

3GPP TS 25.104 V9.2.0 (2009-12)

Technical Specification

3rd Generation Partnership Project; Technical Specification Group Radio Access Network; Base Station (BS) radio transmission and reception (FDD) (Release 9)



The present document has been developed within the 3rd Generation Partnership Project (3GPPTM) and may be further elaborated for the purposes of 3GPP.

The present document has not been subject to any approval process by the 3GPP Organisational Partners and shall not be implemented. This Specification is provided for future development work within 3GPP only. The Organisational Partners accept no liability for any use of this Specification. Specifications and reports for implementation of the 3GPPTM system should be obtained via the 3GPP Organisational Partners' Publications Offices.

Keywords

UMTS, radio

3GPP

Postal address

3GPP support office address

650 Route des Lucioles - Sophia Antipolis
Valbonne - FRANCE
Tel.: +33 4 92 94 42 00 Fax: +33 4 93 65 47 16

Internet

<http://www.3gpp.org>

Copyright Notification

No part may be reproduced except as authorized by written permission.
The copyright and the foregoing restriction extend to reproduction in all media.

© 2009, 3GPP Organizational Partners (ARIB, ATIS, CCSA, ETSI, TTA, TTC).
All rights reserved.

UMTS™ is a Trade Mark of ETSI registered for the benefit of its members
3GPP™ is a Trade Mark of ETSI registered for the benefit of its Members and of the 3GPP Organizational Partners
LTE™ is a Trade Mark of ETSI currently being registered for the benefit of its Members and of the 3GPP Organizational Partners
GSM® and the GSM logo are registered and owned by the GSM Association

Contents

Foreword	7
1 Scope	8
2 References	8
3 Definitions and abbreviations	8
3.1 Definitions	8
3.2 Abbreviations	9
4 General	10
4.1 Relationship between Minimum Requirements and Test Requirements	10
4.2 Base station classes	10
4.3 Regional requirements	11
4.4 Environmental requirements for the BS equipment	12
5 Frequency bands and channel arrangement	12
5.1 General	12
5.2 Frequency bands	13
5.3 Tx-Rx frequency separation	14
5.4 Channel arrangement	14
5.4.1 Channel spacing	14
5.4.2 Channel raster	14
5.4.3 Channel number	14
6 Transmitter characteristics	16
6.1 General	16
6.2 Base station output power	16
6.2.1 Base station maximum output power	16
6.2.1.1 Minimum requirement	17
6.3 Frequency error	17
6.3.1 Minimum requirement	17
6.4 Output power dynamics	17
6.4.1 Inner loop power control in the downlink	18
6.4.1.1 Power control steps	18
6.4.1.1.1 Minimum requirement	18
6.4.2 Power control dynamic range	18
6.4.2.1 Minimum requirements	18
6.4.3 Total power dynamic range	18
6.4.3.1 Minimum requirement	19
6.4.4 Primary CPICH power	19
6.4.4.1 Minimum requirement	19
6.4.5 IPDL time mask	19
6.4.5.1 Minimum Requirement	19
6.4.6 Home base station output power for adjacent channel protection	19
6.4.6.1 Minimum requirement	20
6.5 (void)	20
6.6 Output RF spectrum emissions	20
6.6.1 Occupied bandwidth	20
6.6.1.1 Minimum requirement	21
6.6.2 Out of band emission	21
6.6.2.1 Spectrum emission mask	21
6.6.2.2 Adjacent Channel Leakage power Ratio (ACLR)	24
6.6.2.2.1 Minimum requirement	24
6.6.3 Spurious emissions	25
6.6.3.1 Mandatory Requirements	25
6.6.3.1.1 Spurious emissions (Category A)	25
6.6.3.1.1.1 Minimum Requirement	25
6.6.3.1.1.2 Spurious emissions (Category B)	25

6.6.3.1.2.1	Minimum Requirement	26
6.6.3.2	Protection of the BS receiver of own or different BS	26
6.6.3.2.1	Minimum Requirement	27
6.6.3.3	Co-existence with other systems in the same geographical area	28
6.6.3.3.1	Minimum Requirements	29
6.6.3.4	Co-existence with co-located and co-sited base stations	30
6.6.3.4.1	Minimum Requirements	31
6.6.3.5	Co-existence with PHS	32
6.6.3.5.1	Minimum Requirement	33
6.6.3.6	Co-existence with services in adjacent frequency bands	33
6.6.3.6.1	Minimum requirement	33
6.6.3.7	Co-existence with UTRA-TDD	33
6.6.3.7.1	Operation in the same geographic area	33
6.6.3.7.1.1	Minimum Requirement	33
6.6.3.7.2	Co-located base stations	34
6.6.3.7.2.1	Minimum Requirement	34
6.6.3.8	Protection of Public Safety Operations	34
6.6.3.8.1	Minimum Requirement	34
6.6.3.9	Co-existence with Home BS operating in other bands	34
6.6.3.9.1	Minimum Requirements	35
6.7	Transmit intermodulation	36
6.7.1	Minimum requirement	36
6.8	Transmit modulation	36
6.8.1	Transmit pulse shape filter	36
6.8.2	Error Vector Magnitude	37
6.8.2.1	Minimum requirement	37
6.8.3	Peak code Domain error	37
6.8.3.1	Minimum requirement	37
6.8.4	Time alignment error in Tx diversity, MIMO transmission, DC-HSDPA and DB-DC-HSDPA	37
6.8.4.1	Minimum Requirement	37
6.8.5	Relative Code Domain Error for 64QAM modulation	38
6.8.5.1	Minimum requirement	38
7	Receiver characteristics	38
7.1	General	38
7.2	Reference sensitivity level	38
7.2.1	Minimum requirement	39
7.2.2	Maximum Frequency Deviation for Receiver Performance	39
7.3	Dynamic range	39
7.3.1	Minimum requirement	39
7.4	Adjacent Channel Selectivity (ACS)	39
7.4.1	Minimum requirement	40
7.4.2	Minimum requirement - Co-location with UTRA-TDD	40
7.5	Blocking characteristics	40
7.5.1	Minimum requirement	41
7.5.2	Minimum Requirement - Co-location with GSM900, DCS 1800, PCS1900, GSM850, UTRA FDD and/or E-UTRA FDD	47
7.5.3	Minimum Requirement - Co-location with UTRA-TDD	49
7.6	Intermodulation characteristics	50
7.6.1	Minimum requirement	50
7.7	Spurious emissions	51
7.7.1	Minimum requirement	52
8	Performance requirement	53
8.1	General	53
8.2	Demodulation in static propagation conditions	54
8.2.1	Demodulation of DCH	54
8.2.1.1	Minimum requirement	54
8.3	Demodulation of DCH in multipath fading conditions	54
8.3.1	Multipath fading Case 1	54
8.3.1.1	Minimum requirement	54
8.3.2	Multipath fading Case 2	55

8.3.2.1	Minimum requirement.....	55
8.3.3	Multipath fading Case 3.....	55
8.3.3.1	Minimum requirement.....	56
8.3.4	Multipath fading Case 4.....	56
8.3.4.1	Minimum requirement.....	56
8.4	Demodulation of DCH in moving propagation conditions.....	56
8.4.1	Minimum requirement.....	57
8.5	Demodulation of DCH in birth/death propagation conditions.....	57
8.5.1	Minimum requirement.....	57
8.5A	Demodulation of DCH in high speed train conditions.....	57
8.5A.1	General.....	57
8.5A.2	Minimum requirement.....	58
8.6	(void).....	58
8.7	Performance requirement for RACH.....	58
8.7.1	Performance requirement for RACH preamble detection.....	58
8.7.2	Demodulation of RACH message.....	59
8.7.2.1	Minimum requirements for Static Propagation Condition.....	59
8.7.2.2	Minimum requirements for Multipath Fading Case 3.....	59
8.7.2.3	Minimum requirements for high speed train conditions.....	60
8.8	(void).....	61
8.9	(void).....	61
8.10	Performance of ACK/NACK detection for HS-DPCCH.....	61
8.10.1	ACK false alarm.....	61
8.10.2	ACK mis-detection.....	62
8.11	Demodulation of E-DPDCH in multipath fading condition.....	62
8.12	Performance of signaling detection for E-DPCCH in multipath fading condition.....	63

Annex A (normative):	Measurement channels.....	65
A.1	Summary of UL reference measurement channels.....	65
A.2	UL reference measurement channel for 12.2 kbps.....	66
A.3	UL reference measurement channel for 64 kbps.....	67
A.4	UL reference measurement channel for 144 kbps.....	68
A.5	UL reference measurement channel for 384 kbps.....	69
A.6	(void).....	69
A.7	Reference measurement channels for UL RACH	70
A.8	Reference measurement channel for HS-DPCCH.....	70
A.9	Summary of E-DPDCH Fixed reference channels.....	71
A.10	E-DPDCH Fixed reference channel 1 (FRC1)	71
A.11	E-DPDCH Fixed reference channel 2 (FRC2)	72
A.12	E-DPDCH Fixed reference channel 3 (FRC3)	73
A.13	E-DPDCH Fixed reference channel 4 (FRC4)	74
A.14	E-DPDCH Fixed reference channel 5 (FRC5)	75
A.15	E-DPDCH Fixed reference channel 6 (FRC6)	76
A.16	E-DPDCH Fixed reference channel 7 (FRC7)	76
A.17	E-DPDCH Fixed reference channel 8 (FRC8)	77
Annex B (normative):	Propagation conditions.....	79
B.1	Static propagation condition.....	79
B.2	Multi-path fading propagation conditions.....	79
B.3	Moving propagation conditions	79
B.4	Birth-Death propagation conditions	80
B.4A	High speed train conditions.....	81
B.5	Multipath fading propagation conditions for E-DPDCH and E-DPCCH	83
Annex C (normative):	Characteristics of the W-CDMA interference signal	84
Annex D (informative):	Change History	85

Foreword

This Technical Specification has been produced by the 3GPP.

The contents of the present document are subject to continuing work within the TSG and may change following formal TSG approval. Should the TSG modify the contents of this TS, it will be re-released by the TSG with an identifying change of release date and an increase in version number as follows:

Version 3.y.z

where:

- x the first digit:
 - 1 presented to TSG for information;
 - 2 presented to TSG for approval;
 - 3 Indicates TSG approved document under change control.
- y the second digit is incremented for all changes of substance, i.e. technical enhancements, corrections, updates, etc.
- z the third digit is incremented when editorial only changes have been incorporated in the specification.

1 Scope

This document establishes the Base Station minimum RF characteristics of the FDD mode of UTRA.

2 References

The following documents contain provisions which, through reference in this text, constitute provisions of the present document.

- References are either specific (identified by date of publication, edition number, version number, etc.) or non-specific.
- For a specific reference, subsequent revisions do not apply.
- For a non-specific reference, the latest version applies. In the case of a reference to a 3GPP document (including a GSM document), a non-specific reference implicitly refers to the latest version of that document *in the same Release as the present document*.

- [1] ITU-R Recommendation SM.329, " Unwanted emissions in the spurious domain ".
 - [2] (void)
 - [3] ETSI ETR 273-1-2: "Electromagnetic compatibility and Radio spectrum Matters (ERM); Improvement of radiated methods of measurement (using test sites) and evaluation of the corresponding measurement uncertainties; Part 1: Uncertainties in the measurement of mobile radio equipment characteristics; Sub-part 2: Examples and annexes".
 - [4] 3GPP TR 25.942 "RF System Scenarios".
 - [5] 3GPP TS 45.004: "Digital cellular telecommunications system (Phase 2+); Modulation".
 - [6] 3GPP TS 25.213: "Spreading and modulation (FDD)".
 - [7] ITU-R recommendation SM.328: "Spectra and bandwidth of emissions".
 - [8] 3GPP TS 36.104: "Evolved Universal Terrestrial Radio Access (E-UTRA); Base Station (BS) radio transmission and reception".
-

3 Definitions and abbreviations

3.1 Definitions

For the purposes of the present document, the following definitions apply:

Output power: The mean power of one carrier of the base station, delivered to a load with resistance equal to the nominal load impedance of the transmitter.

Rated output power: Rated output power of the base station is the mean power level per carrier that the manufacturer has declared to be available at the antenna connector.

Maximum output Power: The mean power level per carrier of the base station measured at the antenna connector in a specified reference condition.

Mean power: When applied to a W-CDMA modulated signal this is the power (transmitted or received) in a bandwidth of at least $(1 + \alpha)$ times the chip rate of the radio access mode. The period of measurement shall be at least one timeslot unless otherwise stated.

Power control dynamic range: The difference between the maximum and the minimum transmit output power of a code channel for a specified reference condition.

RRC filtered mean power: The mean power as measured through a root raised cosine filter with roll-off factor α and a bandwidth equal to the chip rate of the radio access mode.

NOTE 1: The RRC filtered mean power of a perfectly modulated W-CDMA signal is 0.246 dB lower than the mean power of the same signal.

Code domain power: That part of the mean power which correlates with a particular (OVSF) code channel. The sum of all powers in the code domain equals the mean power in a bandwidth of $(1 + \alpha)$ times the chip rate of the radio access mode.

Total power dynamic range: The difference between the maximum and the minimum total transmit output power for a specified reference condition.

NOTE 2: The roll-off factor α is defined in section 6.8.1.

3.2 Abbreviations

For the purposes of the present document, the following abbreviations apply:

16QAM	16 Quadrature Amplitude Modulation
ACIR	Adjacent Channel Interference Ratio
ACLR	Adjacent Channel Leakage power Ratio
ACS	Adjacent Channel Selectivity
BS	Base Station
BER	Bit Error Ratio
BLER	Block Error Ratio
CW	Continuous Wave (unmodulated signal)
DB-DC-HSDPA	Dual Band Dual Cell HSDPA
DC-HSDPA	Dual Cell HSDPA
DC-HSUPA	Dual Cell HSUPA
DL	Down Link (forward link)
FDD	Frequency Division Duplexing
GSM	Global System for Mobile Communications
HSDPA	High Speed Downlink Packet Access
HSUPA	High Speed Uplink Packet Access
MIMO	Multiple Input Multiple Output
P_{out}	Output Power
P_{RAT}	Rated Output Power
PHS	Personal Handyphone System
PPM	Parts Per Million
QPSK	Quadrature Phase Shift Keying
RSSI	Received Signal Strength Indicator
SIR	Signal to Interference ratio
TDD	Time Division Duplexing
TPC	Transmit Power Control
UARFCN	UTRA Absolute Radio Frequency Channel Number
UE	User Equipment
UL	Up Link (reverse link)
WCDMA	Wideband Code Division Multiple Access

4 General

4.1 Relationship between Minimum Requirements and Test Requirements

The Minimum Requirements given in this specification make no allowance for measurement uncertainty. The test specification 25.141 section 4 defines Test Tolerances. These Test Tolerances are individually calculated for each test. The Test Tolerances are used to relax the Minimum Requirements in this specification to create Test Requirements.

The measurement results returned by the Test System are compared - without any modification - against the Test Requirements as defined by the shared risk principle.

The Shared Risk principle is defined in ETR 273 Part 1 sub-part 2 section 6.5.

4.2 Base station classes

The requirements in this specification apply to Wide Area Base Stations, Medium Range Base Stations, Local Area Base Stations and Home Base Stations unless otherwise stated.

Wide Area Base Stations are characterised by requirements derived from Macro Cell scenarios with a BS to UE minimum coupling loss equals to 70 dB. The Wide Area Base Station class has the same requirements as the base station for General Purpose application in Release 99, 4 and 5.

Medium Range Base Stations are characterised by requirements derived from Micro Cell scenarios with a BS to UE minimum coupling loss equals to 53 dB.

Local Area Base Stations are characterised by requirements derived from Pico Cell scenarios with a BS to UE minimum coupling loss equals to 45 dB.

Home Base Stations are characterised by requirements derived from Femto Cell scenarios.

4.3 Regional requirements

Some requirements in TS 25.104 may only apply in certain regions. Table 4.1 lists all requirements that may be applied differently in different regions.

Table 4.1: List of regional requirements

Clause number	Requirement	Comments
5.2	Frequency bands	Some bands may be applied regionally.
5.3	Tx-Rx Frequency Separation	The requirement is applied according to what frequency bands in Clause 5.2 that are supported by the BS.
5.4	Channel arrangement	The requirement is applied according to what frequency bands in Clause 5.2 that are supported by the BS.
6.2.1	Base station maximum output power	In certain regions, the minimum requirement for normal conditions may apply also for some conditions outside the range of conditions defined as normal.
6.6.2.1	Spectrum emission mask	The mask specified may be mandatory in certain regions. In other regions this mask may not be applied.
6.6.2.2.1	Adjacent Channel Leakage power Ratio	In Japan, the requirement depicted in the note of Table 6.7 shall be applied.
6.6.3.1.1	Spurious emissions (Category A)	These requirements shall be met in cases where Category A limits for spurious emissions, as defined in ITU-R Recommendation SM.329 [1], are applied.
6.6.3.1.2	Spurious emissions (Category B)	These requirements shall be met in cases where Category B limits for spurious emissions, as defined in ITU-R Recommendation SM.329 [1], are applied.
6.6.3.3	Co-existence with other systems in the same geographical area	These requirements may apply in geographic areas in which both UTRA FDD and GSM900, DCS1800, PCS1900, GSM850 and/or UTRA FDD operating in another frequency band are deployed.
6.6.3.4	Co-existence with co-located and co-sited base stations	These requirements may be applied for the protection of other BS receivers when GSM900, DCS1800, PCS1900, GSM850 and/or FDD BS operating in another frequency band are co-located with a UTRA FDD BS.
6.6.3.5	Co-existence with PHS	This requirement may be applied for the protection of PHS in geographic areas in which both PHS and UTRA FDD are deployed.
6.6.3.6	Co-existence with services in adjacent frequency bands	This requirement may be applied for the protection in bands adjacent to the downlink bands as defined in clause 5.2 in geographic areas in which both an adjacent band service and UTRA FDD are deployed.
6.6.3.7.1	Co-existence with UTRA TDD - Operation in the same geographic area	This requirement may be applied to geographic areas in which both UTRA-TDD and UTRA-FDD are deployed.
6.6.3.7.2	Co-existence with UTRA TDD - Co-located base stations	This requirement may be applied for the protection of UTRA-TDD BS receivers when UTRA-TDD BS and UTRA FDD BS are co-located.
6.6.3.8	Protection of public safety operations	This requirement shall be applied to BS operating in Bands XIII and XIV to ensure that appropriate interference protection is provided to 700 MHz public safety operations.
7.4.2	Adjacent Channel Selectivity Co-location with UTRA-TDD	This requirement may be applied for the protection of UTRA-FDD BS receivers when UTRA-FDD BS and UTRA-TDD BS are co-located.
7.5	Blocking characteristic	The requirement is applied according to what frequency bands in Clause 5.2 that are supported by the BS.

7.5.2	Blocking characteristics Co-location with GSM900, DCS 1800, PCS1900 and/or UTRA	This requirement may be applied for the protection of UTRA FDD BS receivers when UTRA FDD BS and GSM 900, DCS1800, PCS1900, GSM850 and/or UTRA BS (operating in different frequency bands) are co-located.
7.5.3	Blocking characteristics Co-location with UTRA TDD	This requirement may be applied for the protection of UTRA FDD BS receivers when UTRA FDD BS and UTRA TDD BS are co-located.
7.6	Intermodulation characteristics	The requirement is applied according to what frequency bands in Clause 5.2 that are supported by the BS.
7.7	Spurious emissions	The requirement is applied according to what frequency bands in Clause 5.2 that are supported by the BS.
7.7.1	Additional spurious emissions requirement	The requirement in Table 7.8 may be applied to geographic areas in which both UTRA-TDD and UTRA-FDD are deployed.
	Base station classes*	Only requirements for Wide Area (General Purpose), Medium Range and Local Area Base Stations are applicable in Japan.

Note *: Base station classes; This regional requirement should be reviewed to check its necessity every TSG RAN meeting.

4.4 Environmental requirements for the BS equipment

The BS equipment shall fulfil all the requirements in the full range of environmental conditions for the relevant environmental class from the relevant IEC specifications listed below

60 721-3-3 "Stationary use at weather protected locations"

60 721-3-4 "Stationary use at non weather protected locations"

Normally it should be sufficient for all tests to be conducted using normal test conditions except where otherwise stated. For guidance on the use of test conditions to be used in order to show compliance refer to TS 25.141.

5 Frequency bands and channel arrangement

5.1 General

The information presented in this section is based on a chip rate of 3.84 Mcps.

NOTE 1: Other chip rates may be considered in future releases.

5.2 Frequency bands

- a) UTRA/FDD is designed to operate in the following paired bands:

Table 5.0: Frequency bands

Operating Band	UL Frequencies UE transmit, Node B receive	DL frequencies UE receive, Node B transmit
I	1920 - 1980 MHz	2110 -2170 MHz
II	1850 -1910 MHz	1930 -1990 MHz
III	1710-1785 MHz	1805-1880 MHz
IV	1710-1755 MHz	2110-2155 MHz
V	824 - 849MHz	869-894MHz
VI	830-840 MHz	875-885 MHz
VII	2500 - 2570 MHz	2620 - 2690 MHz
VIII	880 - 915 MHz	925 - 960 MHz
IX	1749.9 - 1784.9 MHz	1844.9 - 1879.9 MHz
X	1710-1770 MHz	2110-2170 MHz
XI	1427.9 - 1447.9 MHz	1475.9 - 1495.9 MHz
XII	698 - 716 MHz	728 - 746 MHz
XIII	777 - 787 MHz	746 - 756 MHz
XIV	788 - 798 MHz	758 - 768 MHz
XV	Reserved	Reserved
XVI	Reserved	Reserved
XVII	Reserved	Reserved
XVIII	Reserved	Reserved
XIX	830 – 845 MHz	875 -890 MHz
XXI	1447.9 - 1462.9 MHz	1495.9 - 1510.9 MHz

- b) Deployment in other frequency bands is not precluded
- c) DB-DC-HSDPA is designed to operate in the following configurations:

Table 5.0A: DB-DC-HSDPA configurations

DB-DC-HSDPA Configuration	UL Band	DL Bands
1	I or VIII	I and VIII
2	II or IV	II and IV
3	I or V	I and V

5.3 Tx-Rx frequency separation

- a) UTRA/FDD is designed to operate with the following TX-RX frequency separation:

Table 5.0A: Tx-Rx frequency separation

Operating Band	TX-RX frequency separation
I	190 MHz
II	80 MHz
III	95 MHz
IV	400 MHz
V	45 MHz
VI	45 MHz
VII	120 MHz
VIII	45 MHz
IX	95 MHz
X	400 MHz
XI	48 MHz
XII	30 MHz
XIII	31 MHz
XIV	30 MHz
XIX	45 MHz
XXI	48 MHz

- b) UTRA/FDD can support both fixed and variable transmit to receive frequency separation.
- c) The use of other transmit to receive frequency separations in existing or other frequency bands shall not be precluded.
- d) When configured to operate in DC-HSDPA, the TX-RX frequency separation in Table 5.0A shall be applied to UL and DL with the serving HS-DSCH cell. For band XII, XIII and XIV, the TX-RX frequency separation in Table 5.0A shall be the minimum spacing between UL and any of DL carriers.

5.4 Channel arrangement

5.4.1 Channel spacing

The nominal channel spacing is 5 MHz, but this can be adjusted to optimise performance in a particular deployment scenario.

5.4.2 Channel raster

The channel raster is 200 kHz for all bands, which means that the centre frequency must be an integer multiple of 200 kHz. In addition a number of additional centre frequencies are specified according to table 5.1A, which means that the centre frequencies for these channels are shifted 100 kHz relative to the general raster.

5.4.3 Channel number

The carrier frequency is designated by the UTRA Absolute Radio Frequency Channel Number (UARFCN). For each operating Band, the UARFCN values are defined as follows:

$$\text{Uplink: } N_U = 5 * (F_{UL} - F_{UL_Offset}), \quad \text{for the carrier frequency range } F_{UL_low} \leq F_{UL} \leq F_{UL_high}$$

$$\text{Downlink: } N_D = 5 * (F_{DL} - F_{DL_Offset}), \quad \text{for the carrier frequency range } F_{DL_low} \leq F_{DL} \leq F_{DL_high}$$

For each operating Band, F_{UL_Offset} , F_{UL_low} , F_{UL_high} , F_{DL_Offset} , F_{DL_low} and F_{DL_high} are defined in Table 5.1 for the general UARFCN. For the additional UARFCN, F_{UL_Offset} , F_{DL_Offset} and the specific F_{UL} and F_{DL} are defined in Table 5.1A.

Table 5.1: UARFCN definition (general)

Band	UPLINK (UL) UE transmit, Node B receive			DOWNLINK (DL) UE receive, Node B transmit		
	UARFCN formula offset F_{UL_Offset} [MHz]	Carrier frequency (F_{UL}) range [MHz]		UARFCN formula offset F_{DL_Offset} [MHz]	Carrier frequency (F_{DL}) range [MHz]	
		F_{UL_low}	F_{UL_high}		F_{DL_low}	F_{DL_high}
I	0	1922.4	1977.6	0	2112.4	2167.6
II	0	1852.4	1907.6	0	1932.4	1987.6
III	1525	1712.4	1782.6	1575	1807.4	1877.6
IV	1450	1712.4	1752.6	1805	2112.4	2152.6
V	0	826.4	846.6	0	871.4	891.6
VI	0	832.4	837.6	0	877.4	882.6
VII	2100	2502.4	2567.6	2175	2622.4	2687.6
VIII	340	882.4	912.6	340	927.4	957.6
IX	0	1752.4	1782.4	0	1847.4	1877.4
X	1135	1712.4	1767.6	1490	2112.4	2167.6
XI	733	1430.4	1445.4	736	1478.4	1493.4
XII	-22	700.4	713.6	-37	730.4	743.6
XIII	21	779.4	784.6	-55	748.4	753.6
XIV	12	790.4	795.6	-63	760.4	765.6
XIX	770	832.4	842.6	735	877.4	887.6
XXI	1358	1450.4	1460.4	1326	1498.4	1508.4

Table 5.1A: UARFCN definition (additional channels)

Band	UPLINK (UL) UE transmit, Node B receive		DOWNLINK (DL) UE receive, Node B transmit	
	UARFCN formula offset F_{UL_Offset} [MHz]	Carrier frequency (F_{UL}) [MHz]	UARFCN formula offset F_{DL_Offset} [MHz]	Carrier frequency (F_{DL}) [MHz]
I	-	-	-	-
II	1850.1	1852.5, 1857.5, 1862.5, 1867.5, 1872.5, 1877.5, 1882.5, 1887.5, 1892.5, 1897.5, 1902.5, 1907.5	1850.1	1932.5, 1937.5, 1942.5, 1947.5, 1952.5, 1957.5, 1962.5, 1967.5, 1972.5, 1977.5, 1982.5, 1987.5
III	-	-	-	-
IV	1380.1	1712.5, 1717.5, 1722.5, 1727.5, 1732.5, 1737.5, 1742.5, 1747.5, 1752.5	1735.1	2112.5, 2117.5, 2122.5, 2127.5, 2132.5, 2137.5, 2142.5, 2147.5, 2152.5
V	670.1	826.5, 827.5, 831.5, 832.5, 837.5, 842.5	670.1	871.5, 872.5, 876.5, 877.5, 882.5, 887.5
VI	670.1	832.5, 837.5	670.1	877.5, 882.5
VII	2030.1	2502.5, 2507.5, 2512.5, 2517.5, 2522.5, 2527.5, 2532.5, 2537.5, 2542.5, 2547.5, 2552.5, 2557.5, 2562.5, 2567.5	2105.1	2622.5, 2627.5, 2632.5, 2637.5, 2642.5, 2647.5, 2652.5, 2657.5, 2662.5, 2667.5, 2672.5, 2677.5, 2682.5, 2687.5
VIII	-	-	-	-
IX	-	-	-	-
X	1075.1	1712.5, 1717.5, 1722.5, 1727.5, 1732.5, 1737.5, 1742.5, 1747.5, 1752.5, 1757.5, 1762.5, 1767.5	1430.1	2112.5, 2117.5, 2122.5, 2127.5, 2132.5, 2137.5, 2142.5, 2147.5, 2152.5, 2157.5, 2162.5, 2167.5
XI	-	-	-	-
XII	-39.9	700.5, 701.5, 706.5, 707.5, 712.5, 713.5	-54.9	730.5, 731.5, 736.5, 737.5, 742.5, 743.5
XIII	11.1	779.5, 784.5	-64.9	748.5, 753.5
XIV	2.1	790.5, 795.5	-72.9	760.5, 765.5
XIX	755.1	832.5, 837.5, 842.5	720.1	877.5, 882.5, 887.5
XXI	-	-	-	-

6 Transmitter characteristics

6.1 General

Unless otherwise stated, the requirements in clause 6 are expressed for a single transmitter antenna connector. In case of transmit diversity, DB-DC-HSDPA or MIMO transmission, the requirements apply for each transmitter antenna connector.

A BS supporting DC-HSDPA and DB-DC-HSDPA transmits two cells simultaneously. A BS supporting DC-HSDPA transmits two cells simultaneously on adjacent carrier frequencies.

Unless otherwise stated, the transmitter characteristics are specified at the BS antenna connector (test port A) with a full complement of transceivers for the configuration in normal operating conditions. If any external apparatus such as a TX amplifier, a filter or the combination of such devices is used, requirements apply at the far end antenna connector (port B).

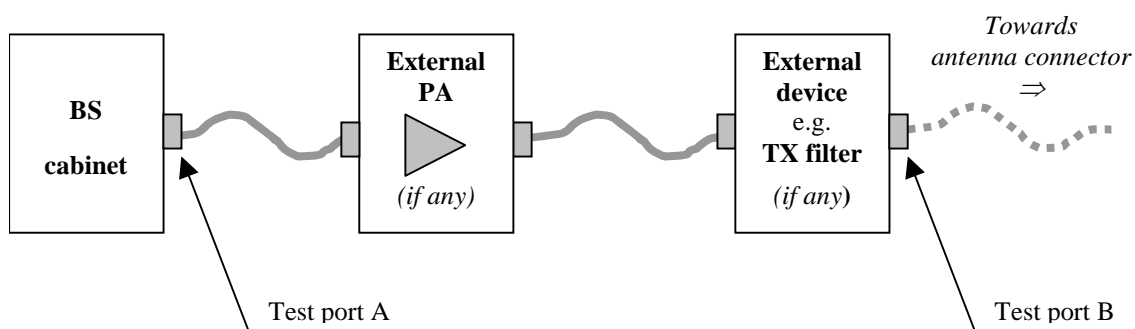

Figure 6.1: Transmitter test ports

6.2 Base station output power

Output power, P_{out} , of the base station is the mean power of one carrier delivered to a load with resistance equal to the nominal load impedance of the transmitter.

Rated output power, PRAT, of the base station is the mean power level per carrier that the manufacturer has declared to be available at the antenna connector.

6.2.1 Base station maximum output power

Maximum output power, P_{max} , of the base station is the mean power level per carrier measured at the antenna connector in specified reference condition.

The rated output power, PRAT, of the BS shall be as specified in Table 6.0A.

Table 6.0A: Base Station rated output power

BS class	PRAT
Wide Area BS	- (note)
Medium Range BS	$\leq +38$ dBm
Local Area BS	$\leq +24$ dBm
Home BS	$\leq +20$ dBm (without transmit diversity or MIMO) $\leq +17$ dBm (with transmit diversity or MIMO)
NOTE: There is no upper limit required for the rated output power of the Wide Area Base Station like for the base station for General Purpose application in Release 99, 4, and 5.	

6.2.1.1 Minimum requirement

In normal conditions, the Base station maximum output power shall remain within +2 dB and -2dB of the manufacturer's rated output power.

In extreme conditions, the Base station maximum output power shall remain within +2.5 dB and -2.5 dB of the manufacturer's rated output power.

In certain regions, the minimum requirement for normal conditions may apply also for some conditions outside the range of conditions defined as normal.

6.3 Frequency error

Frequency error is the measure of the difference between the actual BS transmit frequency and the assigned frequency. The same source shall be used for RF frequency and data clock generation.

6.3.1 Minimum requirement

The modulated carrier frequency of the BS shall be accurate to within the accuracy range given in Table 6.0 observed over a period of one timeslot.

Table 6.0: Frequency error minimum requirement

BS class	Accuracy
Wide Area BS	± 0.05 ppm
Medium Range BS	± 0.1 ppm
Local Area BS	± 0.1 ppm
Home BS	± 0.25 ppm

6.4 Output power dynamics

Power control is used to limit the interference level. The transmitter uses a quality-based power control on the downlink.

6.4.1 Inner loop power control in the downlink

Inner loop power control in the downlink is the ability of the BS transmitter to adjust the transmitter output power of a code channel in accordance with the corresponding TPC symbols received in the uplink.

6.4.1.1 Power control steps

The power control step is the required step change in the code domain power of a code channel in response to the corresponding power control command. The combined output power change is the required total change in the DL transmitted power of a code channel in response to multiple consecutive power control commands corresponding to that code channel.

6.4.1.1.1 Minimum requirement

The BS transmitter shall have the capability of setting the inner loop code domain power with a step sizes of 1dB mandatory and 0.5, 1.5, 2.0 dB optional

- a) The tolerance of the power control step due to inner loop power control shall be within the range shown in Table 6.1.
- b) The tolerance of the combined output power change due to inner loop power control shall be within the range shown in Table 6.2.

Table 6.1: Transmitter power control step tolerance

Power control commands in the down link	Transmitter power control step tolerance							
	2 dB step size		1.5 dB step size		1 dB step size		0.5 dB step size	
	Lower	Upper	Lower	Upper	Lower	Upper	Lower	Upper
Up (TPC command "1")	+1.0 dB	+3.0 dB	+0.75 dB	+2.25 dB	+0.5 dB	+1.5 dB	+0.25 dB	+0.75 dB
Down (TPC command "0")	-1.0 dB	-3.0 dB	-0.75 dB	-2.25 dB	-0.5 dB	-1.5 dB	-0.25 dB	-0.75 dB

Table 6.2: Transmitter aggregated power control step range

Power control commands in the down link	Transmitter aggregated power control step change after 10 consecutive equal commands (up or down)							
	2 dB step size		1.5 dB step size		1 dB step size		0.5 dB step size	
	Lower	Upper	Lower	Upper	Lower	Upper	Lower	Upper
Up (TPC command "1")	+16 dB	+24 dB	+12 dB	+18 dB	+8 dB	+12 dB	+4 dB	+6 dB
Down (TPC command "0")	-16 dB	-24 dB	-12 dB	-18 dB	-8 dB	-12 dB	-4 dB	-6 dB

6.4.2 Power control dynamic range

The power control dynamic range is the difference between the maximum and the minimum code domain power of a code channel for a specified reference condition. Transmit modulation quality shall be maintained within the whole dynamic range as specified in subclause 6.8.

6.4.2.1 Minimum requirements

Down link (DL) power control dynamic range:

Maximum code domain power: BS maximum output power - 3 dB or greater

Minimum code domain power: BS maximum output power - 28 dB or less

6.4.3 Total power dynamic range

The total power dynamic range is the difference between the maximum and the minimum output power for a specified reference condition.

NOTE: The upper limit of the dynamic range is the BS maximum output power. The lower limit of the dynamic range is the lowest minimum power from the BS when no traffic channels are activated.

6.4.3.1 Minimum requirement

The downlink (DL) total power dynamic range shall be 18 dB or greater.

6.4.4 Primary CPICH power

Primary CPICH power is the code domain power of the Common Pilot Channel. Primary CPICH power is indicated on the BCH. CPICH power accuracy is defined as the maximum deviation between the Primary CPICH code domain power indicated on the BCH and the Primary CPICH code domain power measured at the TX antenna interface.

6.4.4.1 Minimum requirement

Primary CPICH code domain power shall be within ± 2.1 dB of the Primary CPICH code domain power indicated on the BCH.

6.4.5 IPDL time mask

To support IPDL location method, the Node B shall interrupt all transmitted signals in the downlink (i.e. common and dedicated channels).

The IPDL time mask specifies the limits of the BS output power during these idle periods.

The requirement in this section shall apply to BS supporting IPDL.

6.4.5.1 Minimum Requirement

The mean power measured over a period starting 27 chips after the beginning of the IPDL period and ending 27 chips before the expiration of the IPDL period shall be equal to or less than

$$\text{BS maximum output power} - 35 \text{ dB}$$

see also Figure 6.1A.

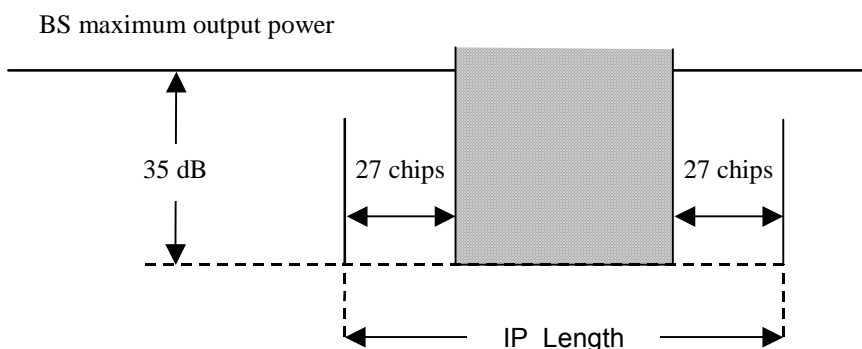

Figure 6.1A: IPDL Time Mask

The requirement applies to all output powers within the total power dynamic range as specified in subclause 6.4.3.

6.4.6 Home base station output power for adjacent channel protection

The Home BS shall be capable of adjusting the transmitter output power to minimize the interference level on the adjacent channels licensed to other operators in the same geographical area while optimize the Home BS coverage. These requirements are only applicable to Home BS. The requirements in this clause are applicable for AWGN radio propagation conditions.

The output power, P_{out} , of the Home BS shall be as specified in Table 6.3 under the following input conditions:

- $CPICH \hat{E}_c$, measured in dBm, is the code power of the Primary CPICH on one of the adjacent channels present at the Home BS antenna connector for the CPICH received on the adjacent channels. If Tx diversity is applied on the Primary CPICH, $CPICH \hat{E}_c$ shall be the sum in [W] of the code powers of the Primary CPICH transmitted from each antenna.
- I_{oh} , measured in dBm, is the total received power density, including signals and interference but excluding the own Home BS signal, present at the Home BS antenna connector on the Home BS operating channel.

In case that both adjacent channels are licensed to other operators, the most stringent requirement shall apply for P_{out} . In case the Home BS's operating channel and both adjacent channels are licensed to the same operator, the requirements of this clause do not apply.

The input conditions defined for the requirements in this section are specified at the antenna connector of the Home BS. For Home BS receivers with diversity, the requirements apply to each antenna connector separately, with the other one(s) terminated or disabled. The requirements are otherwise unchanged. For Home BS(s) without measurement capability, a reference antenna with a gain of 0 dBi is assumed for converting these power levels into field strength requirements.

Table 6.3: Home BS output power for adjacent operator channel protection

Input Conditions	Output power, P_{out} (without transmit diversity or MIMO)	Output power, P_{out} (with transmit diversity or MIMO)
$I_{oh} > CPICH \hat{E}_c + 43 \text{ dB}$ And $CPICH \hat{E}_c \geq -105 \text{ dBm}$	$\leq 10 \text{ dBm}$	$\leq 7 \text{ dBm}$
$I_{oh} \leq CPICH \hat{E}_c + 43 \text{ dB}$ and $CPICH \hat{E}_c \geq -105 \text{ dBm}$	$\leq \max(8 \text{ dBm}, \min(20 \text{ dBm},$ $CPICH \hat{E}_c + 100 \text{ dB}))$	$\leq \max(5 \text{ dBm}, \min(17 \text{ dBm},$ $CPICH \hat{E}_c + 97 \text{ dB}))$

NOTE 1: The Home BS transmitter output power specified in Table 6.3 assumes a Home BS reference antenna gain of 0 dBi, an target outage zone of 47dB around the Home BS for an UE on the adjacent channel, with an allowance of 2 dB for measurement errors, an ACIR of 33 dB, an adjacent channel UE $CPICH \hat{E}_c/I_o$ target of -18 dB and the same $CPICH \hat{E}_c$ value at the adjacent channel UE as for the Home BS.

Note 2: For $CPICH \hat{E}_c < -105 \text{ dBm}$, the requirement in section 6.2.1 applies.

6.4.6.1 Minimum requirement

In normal operating conditions, the output power, P_{out} , of the Home BS shall be equal to or less than the value specified in Table 6.3 plus 2 dB.

In extreme operating conditions, the output power, P_{out} , of the Home BS shall be equal to or less than the value specified in Table 6.3 plus 2.5 dB.

6.5 (void)

6.6 Output RF spectrum emissions

6.6.1 Occupied bandwidth

The occupied bandwidth is the width of a frequency band such that, below the lower and above the upper frequency limits, the mean powers emitted are each equal to a specified percentage $\beta/2$ of the total mean transmitted power. See also ITU-R Recommendation SM.328 [7].

The value of $\beta/2$ shall be taken as 0,5%.

6.6.1.1 Minimum requirement

The occupied channel bandwidth shall be less than 5 MHz based on a chip rate of 3.84 Mcps.

6.6.2 Out of band emission

Out of band emissions are unwanted emissions immediately outside the channel bandwidth resulting from the modulation process and non-linearity in the transmitter but excluding spurious emissions. This out of band emission requirement is specified both in terms of a spectrum emission mask and adjacent channel power ratio for the transmitter.

6.6.2.1 Spectrum emission mask

The mask defined in Tables 6.3 to 6.6 below may be mandatory in certain regions. In other regions this mask may not be applied.

For regions where this clause applies, the requirement shall be met by a base station transmitting on a single RF carrier configured in accordance with the manufacturer's specification. Emissions shall not exceed the maximum level specified in tables 6.3 to 6.6 for the appropriate BS maximum output power, in the frequency range from $\Delta f = 2.5$ MHz to Δf_{max} from the carrier frequency, where:

- Δf is the separation between the carrier frequency and the nominal -3dB point of the measuring filter closest to the carrier frequency.
- F_{offset} is the separation between the carrier frequency and the centre of the measuring filter.
- $f_{offset_{max}}$ is either 12.5 MHz or the offset to the UMTS Tx band edge as defined in section 5.2, whichever is the greater.
- Δf_{max} is equal to $f_{offset_{max}}$ minus half of the bandwidth of the measuring filter.

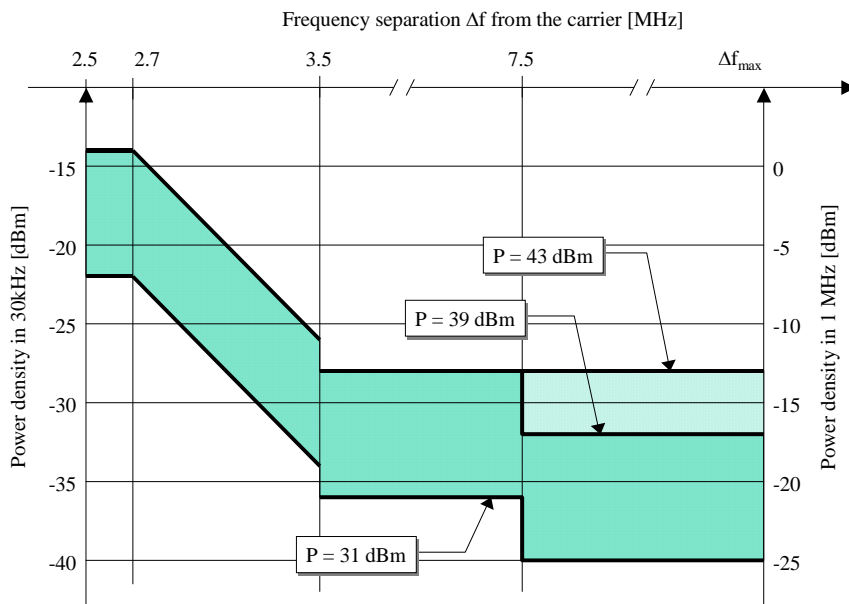

Illustrative diagram of spectrum emission mask

Figure 6.2: Spectrum emission mask

Table 6.3: Spectrum emission mask values, BS maximum output power $P \geq 43$ dBm

Frequency offset of measurement filter -3dB point, Δf	Frequency offset of measurement filter centre frequency, f_{offset}	Minimum requirement	Measurement bandwidth (Note 2)
$2.5 \text{ MHz} \leq \Delta f < 2.7 \text{ MHz}$	$2.515 \text{ MHz} \leq f_{\text{offset}} < 2.715 \text{ MHz}$	-14 dBm	30 kHz
$2.7 \text{ MHz} \leq \Delta f < 3.5 \text{ MHz}$	$2.715 \text{ MHz} \leq f_{\text{offset}} < 3.515 \text{ MHz}$	$-14 \text{ dBm} - 15 \cdot \left(\frac{f_{\text{offset}}}{\text{MHz}} - 2.715 \right) \text{ dB}$	30 kHz
(Note 1)	$3.515 \text{ MHz} \leq f_{\text{offset}} < 4.0 \text{ MHz}$	-26 dBm	30 kHz
$3.5 \text{ MHz} \leq \Delta f \leq \Delta f_{\text{max}}$	$4.0 \text{ MHz} \leq f_{\text{offset}} < f_{\text{offset}_{\text{max}}}$	-13 dBm	1 MHz

Table 6.4: Spectrum emission mask values, BS maximum output power $39 \leq P < 43$ dBm

Frequency offset of measurement filter -3dB point, Δf	Frequency offset of measurement filter centre frequency, f_{offset}	Minimum requirement	Measurement bandwidth (Note 2)
$2.5 \text{ MHz} \leq \Delta f < 2.7 \text{ MHz}$	$2.515 \text{ MHz} \leq f_{\text{offset}} < 2.715 \text{ MHz}$	-14 dBm	30 kHz
$2.7 \text{ MHz} \leq \Delta f < 3.5 \text{ MHz}$	$2.715 \text{ MHz} \leq f_{\text{offset}} < 3.515 \text{ MHz}$	$-14 \text{ dBm} - 15 \cdot \left(\frac{f_{\text{offset}}}{\text{MHz}} - 2.715 \right) \text{ dB}$	30 kHz
(Note 1)	$3.515 \text{ MHz} \leq f_{\text{offset}} < 4.0 \text{ MHz}$	-26 dBm	30 kHz
$3.5 \text{ MHz} \leq \Delta f < 7.5 \text{ MHz}$	$4.0 \text{ MHz} \leq f_{\text{offset}} < 8.0 \text{ MHz}$	-13 dBm	1 MHz
$7.5 \text{ MHz} \leq \Delta f \leq \Delta f_{\text{max}}$	$8.0 \text{ MHz} \leq f_{\text{offset}} < f_{\text{offset}_{\text{max}}}$	$P - 56 \text{ dB}$	1 MHz

Table 6.5: Spectrum emission mask values, BS maximum output power $31 \leq P < 39$ dBm

Frequency offset of measurement filter -3dB point, Δf	Frequency offset of measurement filter centre frequency, f_{offset}	Minimum requirement	Measurement bandwidth (Note 2)
$2.5 \text{ MHz} \leq \Delta f < 2.7 \text{ MHz}$	$2.515 \text{ MHz} \leq f_{\text{offset}} < 2.715 \text{ MHz}$	$P - 53 \text{ dB}$	30 kHz
$2.7 \text{ MHz} \leq \Delta f < 3.5 \text{ MHz}$	$2.715 \text{ MHz} \leq f_{\text{offset}} < 3.515 \text{ MHz}$	$P - 53 \text{ dB} - 15 \cdot \left(\frac{f_{\text{offset}}}{\text{MHz}} - 2.715 \right) \text{ dB}$	30 kHz
(Note 1)	$3.515 \text{ MHz} \leq f_{\text{offset}} < 4.0 \text{ MHz}$	$P - 65 \text{ dB}$	30 kHz
$3.5 \text{ MHz} \leq \Delta f < 7.5 \text{ MHz}$	$4.0 \text{ MHz} \leq f_{\text{offset}} < 8.0 \text{ MHz}$	$P - 52 \text{ dB}$	1 MHz
$7.5 \text{ MHz} \leq \Delta f \leq \Delta f_{\text{max}}$	$8.0 \text{ MHz} \leq f_{\text{offset}} < f_{\text{offset}_{\text{max}}}$	$P - 56 \text{ dB}$	1 MHz

Table 6.6: Spectrum emission mask values, BS maximum output power P < 31 dBm

Frequency offset of measurement filter -3dB point, Δf	Frequency offset of measurement filter centre frequency, f_{offset}	Minimum requirement	Measurement bandwidth (Note 2)
$2.5 \text{ MHz} \leq \Delta f < 2.7 \text{ MHz}$	$2.515 \text{ MHz} \leq f_{\text{offset}} < 2.715 \text{ MHz}$	-22 dBm	30 kHz
$2.7 \text{ MHz} \leq \Delta f < 3.5 \text{ MHz}$	$2.715 \text{ MHz} \leq f_{\text{offset}} < 3.515 \text{ MHz}$	$-22 \text{ dBm} - 15 \cdot \left(\frac{f_{\text{offset}}}{\text{MHz}} - 2.715 \right) \text{ dB}$	30 kHz
(Note 1)	$3.515 \text{ MHz} \leq f_{\text{offset}} < 4.0 \text{ MHz}$	-34 dBm	30 kHz
$3.5 \text{ MHz} \leq \Delta f < 7.5 \text{ MHz}$	$4.0 \text{ MHz} \leq f_{\text{offset}} < 8.0 \text{ MHz}$	-21 dBm	1 MHz
$7.5 \text{ MHz} \leq \Delta f \leq \Delta f_{\text{max}}$	$8.0 \text{ MHz} \leq f_{\text{offset}} < f_{\text{offset}_{\text{max}}}$	-25 dBm	1 MHz

For operation in band II, IV, V, X, XII, XIII and XIV, the applicable additional requirements in Tables 6.6A, 6.6B or 6.6C apply in addition to the minimum requirements in Tables 6.3 to 6.6.

Table 6.6A: Additional spectrum emission limits for Bands II, IV, X

Frequency offset of measurement filter -3dB point, Δf	Frequency offset of measurement filter centre frequency, f_{offset}	Additional requirement	Measurement bandwidth (Note 2)
$2.5 \text{ MHz} \leq \Delta f < 3.5 \text{ MHz}$	$2.515 \text{ MHz} \leq f_{\text{offset}} < 3.515 \text{ MHz}$	-15 dBm	30 kHz
$3.5 \text{ MHz} \leq \Delta f \leq \Delta f_{\text{max}}$	$4.0 \text{ MHz} \leq f_{\text{offset}} < f_{\text{offset}_{\text{max}}}$	-13 dBm	1 MHz

Table 6.6B: Additional spectrum emission limits for Band V

Frequency offset of measurement filter -3dB point, Δf	Frequency offset of measurement filter centre frequency, f_{offset}	Additional requirement	Measurement bandwidth (Note 2)
$2.5 \text{ MHz} \leq \Delta f < 3.5 \text{ MHz}$	$2.515 \text{ MHz} \leq f_{\text{offset}} < 3.515 \text{ MHz}$	-15 dBm	30 kHz
$3.5 \text{ MHz} \leq \Delta f \leq \Delta f_{\text{max}}$	$3.55 \text{ MHz} \leq f_{\text{offset}} < f_{\text{offset}_{\text{max}}}$	-13 dBm	100 kHz

Table 6.6C: Additional spectrum emission limits for Bands XII, XIII, XIV

Frequency offset of measurement filter -3dB point, Δf	Frequency offset of measurement filter centre frequency, f_{offset}	Additional requirement	Measurement bandwidth (Note 2)
$2.5 \text{ MHz} \leq \Delta f < 2.6 \text{ MHz}$	$2.515 \text{ MHz} \leq f_{\text{offset}} < 2.615 \text{ MHz}$	-13 dBm	30 kHz
$2.6 \text{ MHz} \leq \Delta f \leq \Delta f_{\text{max}}$	$2.65 \text{ MHz} \leq f_{\text{offset}} < f_{\text{offset}_{\text{max}}}$	-13 dBm	100 kHz

For Home BS, the applicable additional requirements in Tables 6.6D or 6.6E apply in addition to the minimum requirements in Tables 6.3 to 6.6.

Table 6.6D: Additional spectrum emission limit for Home BS, BS maximum output power $6 \leq P \leq 20$ dBm

Frequency offset of measurement filter -3dB point, Δf	Frequency offset of measurement filter centre frequency, f_{offset}	Additional requirement	Measurement bandwidth (Note 2)
$12.5 \text{ MHz} \leq \Delta f \leq \Delta f_{\text{max}}$	$13\text{MHz} \leq f_{\text{offset}} < f_{\text{offset}_{\text{max}}}$	P - 56 dBm	1 MHz

Table 6.6E: Additional spectrum emission limit for Home BS, BS maximum output power $P < 6$ dBm

Frequency offset of measurement filter -3dB point, Δf	Frequency offset of measurement filter centre frequency, f_{offset}	Additional requirement	Measurement bandwidth (Note 2)
$12.5 \text{ MHz} \leq \Delta f \leq \Delta f_{\text{max}}$	$13\text{MHz} \leq f_{\text{offset}} < f_{\text{offset}_{\text{max}}}$	-50 dBm	1 MHz

Notes for Tables 6.3, 6.4, 6.5 & 6.6

NOTE 1: This frequency range ensures that the range of values of f_{offset} is continuous.

NOTE 2 As a general rule, the resolution bandwidth of the measuring equipment should be equal to the measurement bandwidth. However, to improve measurement accuracy, sensitivity and efficiency, the resolution bandwidth can be smaller than the measurement bandwidth. When the resolution bandwidth is smaller than the measurement bandwidth, the result should be integrated over the measurement bandwidth in order to obtain the equivalent noise bandwidth of the measurement bandwidth.

6.6.2.2 Adjacent Channel Leakage power Ratio (ACLR)

Adjacent Channel Leakage power Ratio (ACLR) is the ratio of the RRC filtered mean power centered on the assigned channel frequency to the RRC filtered mean power centered on an adjacent channel frequency.

The requirements shall apply whatever the type of transmitter considered (single carrier or multi-carrier). It applies for all transmission modes foreseen by the manufacturer's specification.

6.6.2.2.1 Minimum requirement

The ACLR shall be higher than the value specified in Table 6.7.

Table 6.7: BS ACLR

BS adjacent channel offset below the first or above the last carrier frequency used	ACLR limit
5 MHz	45 dB
10 MHz	50 dB
Note 1: In certain regions, the adjacent channel power (the RRC filtered mean power centered on an adjacent channel frequency) shall be less than or equal to -8.0 dBm/3.84 MHz (for Band I, IX, XI and XXI) or +2.0dBm/3.84MHz (for Band VI and XIX) or as specified by the ACLR limit, whichever is the higher. This note is not applicable for Home BS. Note 2: For Home BS, the adjacent channel power (the RRC filtered mean power centered on an adjacent channel frequency) shall be less than or equal to -44.2 dBm/3.84MHz or as specified by the ACLR limit, whichever is the higher.	

6.6.3 Spurious emissions

Spurious emissions are emissions which are caused by unwanted transmitter effects such as harmonics emission, parasitic emission, intermodulation products and frequency conversion products, but exclude out of band emissions. This is measured at the base station RF output port.

The requirements shall apply whatever the type of transmitter considered (single carrier or multiple-carrier). It applies for all transmission modes foreseen by the manufacturer's specification.

The requirements (except 6.6.3.5 and 6.6.3.8) apply at frequencies within the specified frequency ranges, which are more than 12.5MHz below the first carrier frequency used or more than 12.5MHz above the last carrier frequency used.

Unless otherwise stated, all requirements are measured as mean power (RMS).

6.6.3.1 Mandatory Requirements

The requirements of either subclause 6.6.3.1.1 or subclause 6.6.3.1.2 shall apply.

6.6.3.1.1 Spurious emissions (Category A)

The following requirements shall be met in cases where Category A limits for spurious emissions, as defined in ITU-R Recommendation SM.329 [1], are applied.

6.6.3.1.1.1 Minimum Requirement

The power of any spurious emission shall not exceed:

Table 6.8: BS Mandatory spurious emissions limits, Category A

Band	Maximum level	Measurement Bandwidth	Note
9kHz - 150kHz	-13 dBm	1 kHz	Note 1
150kHz - 30MHz		10 kHz	Note 1
30MHz - 1GHz		100 kHz	Note 1
1GHz - 12.75 GHz		1 MHz	Note 2
NOTE 1: Bandwidth as in ITU-R SM.329 [1], s4.1			
NOTE 2: Upper frequency as in ITU-R SM.329 [1], s2.5 table 1			

6.6.3.1.2 Spurious emissions (Category B)

The following requirements shall be met in cases where Category B limits for spurious emissions, as defined in ITU-R Recommendation SM.329 [1], are applied.

6.6.3.1.2.1 Minimum Requirement

The power of any spurious emission shall not exceed:

Table 6.9: BS Mandatory spurious emissions limits, operating band I, II, III, IV, VII, X (Category B)

Band	Maximum Level	Measurement Bandwidth	Note
9 kHz ↔ 150 kHz	-36 dBm	1 kHz	Note 1
150 kHz ↔ 30 MHz	-36 dBm	10 kHz	Note 1
30 MHz ↔ 1 GHz	-36 dBm	100 kHz	Note 1
1 GHz ↔ $F_{low} - 10$ MHz	-30 dBm	1 MHz	Note 1
$F_{low} - 10$ MHz ↔ $F_{high} + 10$ MHz	-15 dBm	1 MHz	Note 2
$F_{high} + 10$ MHz ↔ 12.75 GHz	-30 dBm	1 MHz	Note 3
NOTE 1: Bandwidth as in ITU-R Recommendation SM.329 [1], s4.1			
NOTE 2: Limit based on ITU-R Recommendation SM.329 [1], s4.3 and Annex 7			
NOTE 3: Bandwidth as in ITU-R Recommendation SM.329 [1], s4.1. Upper frequency as in ITU-R SM.329 [1], s2.5 table 1			
Key:			
F_{low} : The lowest downlink frequency of the operating band as defined in Table 5.0.			
F_{high} : The highest downlink frequency of the operating band as defined in Table 5.0.			

Table 6.9A: BS Mandatory spurious emissions limits, operating band V, VIII, XII, XIII, XIV (Category B)

Band	Maximum Level	Measurement Bandwidth	Note
9 kHz ↔ 150 kHz	-36 dBm	1 kHz	Note 1
150 kHz ↔ 30 MHz	-36 dBm	10 kHz	Note 1
30 MHz ↔ $F_{low} - 10$ MHz	-36 dBm	100 kHz	Note 1
$F_{low} - 10$ MHz ↔ $F_{high} + 10$ MHz	-16 dBm	100 kHz	Note 2
$F_{high} + 10$ MHz ↔ 1 GHz	-36 dBm	100 kHz	Note 1
1GHz ↔ 12.75GHz	-30 dBm	1 MHz	Note 3
NOTE 1: Bandwidth as in ITU-R Recommendation SM.329 [1], s4.1			
NOTE 2: Limit based on ITU-R Recommendation SM.329 [1], s4.3 and Annex 7			
NOTE 3: Bandwidth as in ITU-R Recommendation SM.329 [1], s4.1. Upper frequency as in ITU-R SM.329 [1], s2.5 table 1			
Key:			
F_{low} : The lowest downlink frequency of the operating band as defined in Table 5.0.			
F_{high} : The highest downlink frequency of the operating band as defined in Table 5.0.			

Table 6.9B: (void)

Table 6.9C: (void)

Table 6.9D: (void)

Table 6.9E: (void)

Table 6.9F: (void)

Table 6.9G: (void)

6.6.3.2 Protection of the BS receiver of own or different BS

This requirement shall be applied in order to prevent the receivers of the BSs being desensitised by emissions from a BS transmitter. This is measured at the transmit antenna port for any type of BS which has common or separate Tx/Rx antenna ports.

6.6.3.2.1 Minimum Requirement

The power of any spurious emission shall not exceed:

Table 6.10: Wide Area BS Spurious emissions limits for protection of the BS receiver

Operating Band	Band	Maximum Level	Measurement Bandwidth	Note
I	1920 - 1980MHz	-96 dBm	100 kHz	
II	1850-1910 MHz	-96 dBm	100 kHz	
III	1710-1785 MHz	-96 dBm	100 kHz	
IV	1710-1755 MHz	-96 dBm	100 kHz	
V	824-849 MHz	-96 dBm	100 kHz	
VI, XIX	815-850 MHz	-96 dBm	100 kHz	
VII	2500-2570 MHz	-96 dBm	100 kHz	
VIII	880-915 MHz	-96 dBm	100 kHz	
IX	1749.9-1784.9 MHz	-96 dBm	100 kHz	
X	1710-1770 MHz	-96 dBm	100 kHz	
XI	1427.9 - 1447.9 MHz	-96 dBm	100 kHz	
XII	698 - 716 MHz	-96 dBm	100 kHz	
XIII	777 - 787 MHz	-96 dBm	100 kHz	
XIV	788 - 798 MHz	-96 dBm	100 kHz	
XXI	1447.9 - 1462.9 MHz	-96 dBm	100 kHz	

Table 6.10A: Medium Range BS Spurious emissions limits for protection of the BS receiver

Operating Band	Band	Maximum Level	Measurement Bandwidth	Note
I	1920 - 1980MHz	-86 dBm	100 kHz	
II	1850-1910 MHz	-86 dBm	100 kHz	
III	1710-1785 MHz	-86 dBm	100 kHz	
IV	1710-1755 MHz	-86 dBm	100 kHz	
V	824-849 MHz	-86 dBm	100 kHz	
VI, XIX	815-850 MHz	-86 dBm	100 kHz	
VII	2500-2570 MHz	-86 dBm	100 kHz	
VIII	880-915 MHz	-86 dBm	100 kHz	
IX	1749.9-1784.9 MHz	-86 dBm	100 kHz	
X	1710-1770 MHz	-86 dBm	100 kHz	
XI	1427.9 - 1447.9 MHz	-86 dBm	100 kHz	
XII	698 - 716 MHz	-86 dBm	100 kHz	
XIII	777 - 787 MHz	-86 dBm	100 kHz	
XIV	788 - 798 MHz	-86 dBm	100 kHz	
XXI	1447.9 - 1462.9 MHz	-86 dBm	100 kHz	

Table 6.10B: Local Area BS Spurious emissions limits for protection of the BS receiver

Operating Band	Band	Maximum Level	Measurement Bandwidth	Note
I	1920 - 1980MHz	-82 dBm	100 kHz	
II	1850-1910 MHz	-82 dBm	100 kHz	
III	1710-1785 MHz	-82 dBm	100 kHz	
IV	1710-1755 MHz	-82 dBm	100 kHz	
V	824-849 MHz	-82 dBm	100 kHz	
VI, XIX	815-850 MHz	-82 dBm	100 kHz	
VII	2500-2570 MHz	-82 dBm	100 kHz	
VIII	880-915 MHz	-82 dBm	100 kHz	
IX	1749.9-1784.9 MHz	-82 dBm	100 kHz	
X	1710-1770 MHz	-82 dBm	100 kHz	
XI	1427.9 - 1447.9 MHz	-82 dBm	100 kHz	
XII	698 - 716 MHz	-82 dBm	100 kHz	
XIII	777 - 787 MHz	-82 dBm	100 kHz	
XIV	788 - 798 MHz	-82 dBm	100 kHz	
XXI	1447.9 - 1462.9 MHz	-82 dBm	100 kHz	

Table 6.10C: Home BS Spurious emissions limits for protection of the BS receiver

Operating Band	Band	Maximum Level	Measurement Bandwidth	Note
I	1920 - 1980MHz	-82 dBm	100 kHz	
II	1850-1910 MHz	-82 dBm	100 kHz	
III	1710-1785 MHz	-82 dBm	100 kHz	
IV	1710-1755 MHz	-82 dBm	100 kHz	
V	824-849 MHz	-82 dBm	100 kHz	
VI, XIX	815-850 MHz	-82 dBm	100 kHz	
VII	2500-2570 MHz	-82 dBm	100 kHz	
VIII	880-915 MHz	-82 dBm	100 kHz	
IX	1749.9-1784.9 MHz	-82 dBm	100 kHz	
X	1710-1770 MHz	-82 dBm	100 kHz	
XI	1427.9 - 1447.9 MHz	-82 dBm	100 kHz	
XII	698 - 716 MHz	-82 dBm	100 kHz	
XIII	777 - 787 MHz	-82 dBm	100 kHz	
XIV	788 - 798 MHz	-82 dBm	100 kHz	
XXI	1447.9 - 1462.9 MHz	-82 dBm	100 kHz	

6.6.3.3 Co-existence with other systems in the same geographical area

These requirements may be applied for the protection of UE, MS and/or BS operating in other frequency bands in the same geographical area. The requirements may apply in geographic areas in which both a UTRA FDD BS and a system operating in another frequency band than the FDD operating band are deployed. The system operating in the other frequency band may be GSM900, DCS1800, PCS1900, GSM850, E-UTRA FDD and/or UTRA FDD.

6.6.3.3.1 Minimum Requirements

The power of any spurious emission shall not exceed the limits of Table 6.11 for a BS where requirements for co-existence with the system listed in the first column apply.

Table 6.11: BS Spurious emissions limits for UTRA FDD BS in geographic coverage area of systems operating in other frequency bands

System type operating in the same geographical area	Band for co-existence requirement	Maximum Level	Measurement Bandwidth	Note
GSM900	921 - 960 MHz	-57 dBm	100 kHz	This requirement does not apply to UTRA FDD operating in band VIII
	876 - 915 MHz	-61 dBm	100 kHz	For the frequency range 880-915 MHz, this requirement does not apply to UTRA FDD operating in band VIII, since it is already covered by the requirement in sub-clause 6.6.3.2.
DCS1800	1805 - 1880 MHz	-47 dBm	100 kHz	This requirement does not apply to UTRA FDD operating in band III
	1710 - 1785 MHz	-61 dBm	100 kHz	This requirement does not apply to UTRA FDD operating in band III, since it is already covered by the requirement in sub-clause 6.6.3.2.
PCS1900	1930 - 1990 MHz	-47 dBm	100 kHz	This requirement does not apply to UTRA FDD BS operating in frequency band II
	1850 - 1910 MHz	-61 dBm	100 kHz	This requirement does not apply to UTRA FDD BS operating in frequency band II, since it is already covered by the requirement in sub-clause 6.6.3.2.
GSM850 or CDMA850	869 - 894 MHz	-57 dBm	100 kHz	This requirement does not apply to UTRA FDD BS operating in frequency band V
	824 - 849 MHz	-61 dBm	100 kHz	This requirement does not apply to UTRA FDD BS operating in frequency band V, since it is already covered by the requirement in sub-clause 6.6.3.2.
UTRA FDD Band I or E-UTRA Band 1	2110 - 2170 MHz	-52 dBm	1 MHz	This requirement does not apply to UTRA FDD BS operating in band I,
	1920 - 1980 MHz	-49 dBm	1 MHz	This requirement does not apply to UTRA FDD BS operating in band I, since it is already covered by the requirement in sub-clause 6.6.3.2.
UTRA FDD Band II or E-UTRA Band 2	1930 - 1990 MHz	-52 dBm	1 MHz	This requirement does not apply to UTRA FDD BS operating in band II
	1850 - 1910 MHz	-49 dBm	1 MHz	This requirement does not apply to UTRA FDD BS operating in band II, since it is already covered by the requirement in sub-clause 6.6.3.2.
UTRA FDD Band III or E-UTRA Band 3	1805 - 1880 MHz	-52 dBm	1 MHz	This requirement does not apply to UTRA FDD BS operating in band III
	1710 - 1785 MHz	-49 dBm	1 MHz	This requirement does not apply to UTRA FDD BS operating in band III, since it is already covered by the requirement in sub-clause 6.6.3.2.
UTRA FDD Band IV or E-UTRA Band 4	2110 - 2155 MHz	-52 dBm	1 MHz	This requirement does not apply to UTRA FDD BS operating in band IV or band X
	1710 - 1755 MHz	-49 dBm	1 MHz	This requirement does not apply to UTRA FDD BS operating in band IV or band X, since it is already covered by the requirement in sub-clause 6.6.3.2.
UTRA FDD Band V or E-UTRA Band 5	869 - 894 MHz	-52 dBm	1 MHz	This requirement does not apply to UTRA FDD BS operating in band V
	824 - 849 MHz	-49 dBm	1 MHz	This requirement does not apply to UTRA FDD BS operating in band V, since it is already covered by the requirement in sub-clause 6.6.3.2.
UTRA FDD Band VI or XIX, E-UTRA Band 6, 18 or 19	860 - 895 MHz	-52 dBm	1 MHz	This requirement does not apply to UTRA FDD BS operating in band VI or XIX
	815 - 850 MHz	-49 dBm	1 MHz	This requirement does not apply to UTRA FDD BS operating in band VI or XIX, since it is already covered by the requirement in sub-clause 6.6.3.2.
UTRA FDD Band VII or	2620 - 2690 MHz	-52 dBm	1 MHz	This requirement does not apply to UTRA FDD BS operating in band VII,

E-UTRA Band 7	2500 - 2570 MHz	-49 dBm	1 MHz	This requirement does not apply to UTRA FDD BS operating in band VII, since it is already covered by the requirement in sub-clause 6.6.3.2.
UTRA FDD Band VIII or E-UTRA Band 8	925 - 960 MHz	-52 dBm	1 MHz	This requirement does not apply to UTRA FDD BS operating in band VIII.
	880 - 915 MHz	-49 dBm	1 MHz	This requirement does not apply to UTRA FDD BS operating in band VIII, since it is already covered by the requirement in sub-clause 6.6.3.2.
UTRA FDD Band IX or E-UTRA Band 9	1844.9 - 1879.9 MHz	-52 dBm	1 MHz	This requirement does not apply to UTRA FDD BS operating in band IX
	1749.9 - 1784.9 MHz	-49 dBm	1 MHz	This requirement does not apply to UTRA FDD BS operating in band IX, since it is already covered by the requirement in sub-clause 6.6.3.2.
UTRA FDD Band X or E-UTRA Band 10	2110 - 2170 MHz	-52 dBm	1 MHz	This requirement does not apply to UTRA FDD BS operating in band IV or band X.
	1710 - 1770 MHz	-49 dBm	1 MHz	This requirement does not apply to UTRA FDD BS operating in band X, since it is already covered by the requirement in sub-clause 6.6.3.2. For UTRA FDD BS operating in Band IV, it applies for 1755 MHz to 1770 MHz, while the rest is covered in sub-clause 6.6.3.2.
UTRA FDD Band XI or XXI or E-UTRA Band 11	1475.9 - 1510.9 MHz	-52 dBm	1 MHz	This requirement does not apply to UTRA FDD BS operating in band XI or XXI.
	1427.9 - 1447.9 MHz	-49 dBm	1 MHz	This requirement does not apply to UTRA FDD BS operating in band XI, since it is already covered by the requirement in sub-clause 6.6.3.2.
	1447.9 - 1462.9 MHz	-49 dBm	1 MHz	This requirement does not apply to UTRA FDD BS operating in band XXI, since it is already covered by the requirement in sub-clause 6.6.3.2.
UTRA FDD Band XII or E-UTRA Band 12	728 - 746 MHz	-52 dBm	1 MHz	This requirement does not apply to UTRA FDD BS operating in band XII
	698 - 716 MHz	-49 dBm	1 MHz	This requirement does not apply to UTRA FDD BS operating in band XII, since it is already covered by the requirement in sub-clause 6.6.3.2.
UTRA FDD Band XIII or E-UTRA Band 13	746 - 756 MHz	-52 dBm	1 MHz	This requirement does not apply to UTRA FDD BS operating in band XIII
	777 - 787 MHz	-49 dBm	1 MHz	This requirement does not apply to UTRA FDD BS operating in band XIII, since it is already covered by the requirement in sub-clause 6.6.3.2.
UTRA FDD Band XIV or E-UTRA Band 14	758 - 768 MHz	-52 dBm	1 MHz	This requirement does not apply to UTRA FDD BS operating in band XIV
	788 - 798 MHz	-49 dBm	1 MHz	This requirement does not apply to UTRA FDD BS operating in band XIV, since it is already covered by the requirement in sub-clause 6.6.3.2.
E-UTRA Band 17	734 - 746 MHz	-52 dBm	1 MHz	This requirement does not apply to UTRA FDD BS operating in band XII
	704 - 716 MHz	-49 dBm	1 MHz	This requirement does not apply to UTRA FDD BS operating in band XII, since it is already covered by the requirement in sub-clause 6.6.3.2.

6.6.3.4 Co-existence with co-located and co-sited base stations

These requirements may be applied for the protection of other BS receivers when GSM900, DCS1800, PCS1900, GSM850, E-UTRA FDD and/or UTRA FDD BS are co-located with a UTRA FDD BS.

The requirements in this chapter assume a 30 dB coupling loss between transmitter and receiver. If BSs of different classes are co-sited, the coupling loss should be increased by the value as stated in TR 25.942 [4] chapter 10.3 in Table 10.1 and Table 10.2.

6.6.3.4.1 Minimum Requirements

The power of any spurious emission shall not exceed the limits of Table 6.12 for a Wide Area (WA) BS where requirements for co-location with a BS type listed in the first column apply.

Table 6.12: BS Spurious emissions limits for Wide Area BS co-located with another BS

Type of co-located BS	Band for co-location requirement	Maximum Level	Measurement Bandwidth	Note
Macro GSM900	876-915 MHz	-98 dBm	100 kHz	
Macro DCS1800	1710 - 1785 MHz	-98 dBm	100 kHz	
Macro PCS1900	1850 - 1910 MHz	-98 dBm	100 kHz	
Macro GSM850 or CDMA850	824 - 849 MHz	-98 dBm	100 kHz	
WA UTRA FDD Band I or E-UTRA Band 1	1920 - 1980 MHz	-96 dBm	100 kHz	
WA UTRA FDD Band II or E-UTRA Band 2	1850 - 1910 MHz	-96 dBm	100 kHz	
WA UTRA FDD Band III or E-UTRA Band 3	1710 - 1785 MHz	-96 dBm	100 kHz	
WA UTRA FDD Band IV or E-UTRA Band 4	1710 - 1755 MHz	-96 dBm	100 kHz	
WA UTRA FDD Band V or E-UTRA Band 5	824 - 849 MHz	-96 dBm	100 kHz	
WA UTRA FDD Band VI or XIX, or E-UTRA Band 6, 18 or 19	815 - 850 MHz	-96 dBm	100 kHz	
WA UTRA FDD Band VII or E-UTRA Band 7	2500 - 2570 MHz	-96 dBm	100 KHz	
WA UTRA FDD Band VIII or E-UTRA Band 8	880 - 915 MHz	-96 dBm	100 KHz	
WA UTRA FDD Band IX or E-UTRA Band 9	1749.9 - 1784.9 MHz	-96 dBm	100 KHz	
WA UTRA FDD Band X or E-UTRA Band 10	1710 - 1770 MHz	-96 dBm	100 kHz	
WA UTRA FDD Band XI or E-UTRA Band 11	1427.9 - 1447.9 MHz	-96 dBm	100 kHz	
WA UTRA FDD Band XII or E-UTRA Band 12	698 - 716 MHz	-96 dBm	100 KHz	
WA UTRA FDD Band XIII or E-UTRA Band 13	777 - 787 MHz	-96 dBm	100 kHz	
WA UTRA FDD Band XIV or E-UTRA Band 14	788 - 798 MHz	-96 dBm	100 kHz	
E-UTRA Band 17	704 - 716 MHz	-96 dBm	100 KHz	
WA UTRA FDD Band XXI	1447.9 - 1462.9 MHz	-96 dBm	100 kHz	

The power of any spurious emission shall not exceed the limits of Table 6.13 for a Medium Range (MR) BS where requirements for co-location with a BS type listed in the first column apply.

Table 6.13: BS Spurious emissions limits for Medium Range BS co-located with another BS

Type of co-located BS	Band for co-location requirement	Maximum Level	Measurement Bandwidth	Note
Micro GSM900	876-915 MHz	-91 dBm	100 kHz	
Micro DCS1800	1710 - 1785 MHz	-96 dBm	100 kHz	
Micro PCS1900	1850 - 1910 MHz	-96 dBm	100 kHz	
Micro GSM850	824 - 849 MHz	-91 dBm	100 kHz	
MR UTRA FDD Band I	1920 - 1980 MHz	-86 dBm	100 kHz	
MR UTRA FDD Band II	1850 - 1910 MHz	-86 dBm	100 kHz	
MR UTRA FDD Band III	1710 - 1785 MHz	-86 dBm	100 kHz	
MR UTRA FDD Band IV	1710 - 1755 MHz	-86 dBm	100 kHz	
MR UTRA FDD Band V	824 - 849 MHz	-86 dBm	100 kHz	
MR UTRA FDD Band VI or XIX	815 - 850 MHz	-86 dBm	100 kHz	
MR UTRA FDD Band VII	2500 - 2570 MHz	-86 dBm	100 KHz	
MR UTRA FDD Band VIII	880 - 915 MHz	-86 dBm	100 KHz	
MR UTRA FDD Band IX	1749.9 - 1784.9 MHz	-86 dBm	100 KHz	
MR UTRA FDD Band X	1710 - 1770 MHz	-86 dBm	100 kHz	
MR UTRA FDD Band XI	1427.9 - 1447.9 MHz	-86 dBm	100 kHz	
MR UTRA FDD Band XII	698 - 716 MHz	-86 dBm	100 KHz	
MR UTRA FDD Band XIII	777 - 787 MHz	-86 dBm	100 kHz	
MR UTRA FDD Band XIV	788 - 798 MHz	-86 dBm	100 kHz	
MR UTRA FDD Band XXI	1447.9 - 1462.9 MHz	-86 dBm	100 kHz	

The power of any spurious emission shall not exceed the limits of Table 6.14 for a Local Area (LA) BS where requirements for co-location with a BS type listed in the first column apply.

Table 6.14: BS Spurious emissions limits for Local Area BS co-located with another BS

Type of co-located BS	Band for co-location requirement	Maximum Level	Measurement Bandwidth	Note
Pico GSM900	876-915 MHz	-70 dBm	100 kHz	
Pico DCS1800	1710 - 1785 MHz	-80 dBm	100 kHz	
Pico PCS1900	1850 - 1910 MHz	-80 dBm	100 kHz	
Pico GSM850	824 - 849 MHz	-70 dBm	100 kHz	
LA UTRA FDD Band I	1920 - 1980 MHz	-82 dBm	100 kHz	
LA UTRA FDD Band II	1850 - 1910 MHz	-82 dBm	100 kHz	
LA UTRA FDD Band III	1710 - 1785 MHz	-82 dBm	100 kHz	
LA UTRA FDD Band IV	1710 - 1755 MHz	-82 dBm	100 kHz	
LA UTRA FDD Band V	824 - 849 MHz	-82 dBm	100 kHz	
LA UTRA FDD Band VI or XIX	815 - 850 MHz	-82 dBm	100 kHz	
LA UTRA FDD Band VII	2500 - 2570 MHz	-82 dBm	100 KHz	
LA UTRA FDD Band VIII	880 - 915 MHz	-82 dBm	100 KHz	
LA UTRA FDD Band IX	1749.9 - 1784.9 MHz	-82 dBm	100 KHz	
LA UTRA FDD Band X	1710 - 1770 MHz	-82 dBm	100 kHz	
LA UTRA FDD Band XI	1427.9 - 1447.9 MHz	-82 dBm	100 kHz	
LA UTRA FDD Band XII	698 - 716 MHz	-82 dBm	100 KHz	
LA UTRA FDD Band XIII	777 - 787 MHz	-82 dBm	100 kHz	
LA UTRA FDD Band XIV	788 - 798 MHz	-82 dBm	100 kHz	
LA UTRA FDD Band XXI	1447.9 - 1462.9 MHz	-82 dBm	100 kHz	

6.6.3.5 Co-existence with PHS

This requirement may be applied for the protection of PHS in geographic areas in which both PHS and UTRA FDD are deployed. This requirement is also applicable at specified frequencies falling between 12.5MHz below the first carrier frequency used and 12.5MHz above the last carrier frequency used.

6.6.3.5.1 Minimum Requirement

The power of any spurious emission shall not exceed:

Table 6.15: BS Spurious emissions limits for BS in geographic coverage area of PHS

Band	Maximum Level	Measurement Bandwidth	Note
1884.5 - 1919.6 MHz	-41 dBm	300 kHz	

6.6.3.6 Co-existence with services in adjacent frequency bands

This requirement may be applied for the protection in bands adjacent to bands I, II, III or VII as defined in clause 5.2 in geographic areas in which both an adjacent band service and UTRA FDD are deployed.

6.6.3.6.1 Minimum requirement

The power of any spurious emission shall not exceed:

Table 6.16: BS spurious emissions limits for protection of adjacent band services

Operating Band	Band	Maximum Level	Measurement Bandwidth	Note
I	2100-2105 MHz	$-30 + 3.4 \cdot (f - 2100 \text{ MHz}) \text{ dBm}$	1 MHz	
	2175-2180 MHz	$-30 + 3.4 \cdot (2180 \text{ MHz} - f) \text{ dBm}$	1 MHz	
II	1920-1925 MHz	$-30 + 3.4 \cdot (f - 1920 \text{ MHz}) \text{ dBm}$	1 MHz	
	1995-2000 MHz	$-30 + 3.4 \cdot (2000 \text{ MHz} - f) \text{ dBm}$	1 MHz	
III	1795-1800 MHz	$-30 + 3.4 \cdot (f - 1795 \text{ MHz}) \text{ dBm}$	1MHz	
	1885-1890 MHz	$-30 + 3.4 \cdot (1890 \text{ MHz} - f) \text{ dBm}$	1MHz	
VII	2610-2615 MHz	$-30 + 3.4 \cdot (f - 2610 \text{ MHz}) \text{ dBm}$	1 MHz	
	2695-2700 MHz	$-30 + 3.4 \cdot (2700 \text{ MHz} - f) \text{ dBm}$	1 MHz	

NOTE: This requirement for the frequency range 2610-2615 MHz may be applied to geographic areas in which both UTRA-TDD and UTRA-FDD are deployed.

6.6.3.7 Co-existence with UTRA-TDD

6.6.3.7.1 Operation in the same geographic area

This requirement may be applied to geographic areas in which both UTRA-TDD and UTRA-FDD are deployed.

6.6.3.7.1.1 Minimum Requirement

The power of any spurious emission shall not exceed:

Table 6.17: BS Spurious emissions limits for BS in geographic coverage area of UTRA-TDD

Band	Maximum Level	Measurement Bandwidth	Note
1900 - 1920 MHz	-52 dBm	1 MHz	
2010 - 2025 MHz	-52 dBm	1 MHz	
2570 - 2610 MHz	-52 dBm	1 MHz	
2300 - 2400 MHz	-52 dBm	1 MHz	
1880 - 1920MHz	-52 dBm	1 MHz	Applicable in China

6.6.3.7.2 Co-located base stations

This requirement may be applied for the protection of UTRA-TDD BS receivers when UTRA-TDD BS and UTRA FDD BS are co-located.

6.6.3.7.2.1 Minimum Requirement

The power of any spurious emission shall not exceed:

Table 6.18: BS Spurious emissions limits for BS co-located with UTRA-TDD

BS class	Band	Maximum Level	Measurement Bandwidth	Note
Wide Area BS	1900 - 1920 MHz	-86 dBm	1 MHz	
Local Area BS	1900 - 1920 MHz	-72 dBm	1 MHz	
Wide Area BS	2010 - 2025 MHz	-86 dBm	1 MHz	
Local Area BS	2010 - 2025 MHz	-72 dBm	1 MHz	
Wide Area BS	2570 - 2610 MHz	-86 dBm	1 MHz	
Local Area BS	2570 - 2610 MHz	-72 dBm	1 MHz	
Wide Area BS	2300 - 2400 MHz	-86 dBm	1 MHz	
Local Area BS	2300 - 2400 MHz	-72 dBm	1 MHz	
Wide Area BS	1880 - 1920 MHz	-86 dBm	1 MHz	Applicable in China
Local Area BS	1880 - 1920 MHz	-72 dBm	1 MHz	Applicable in China

These values assume a 30 dB coupling loss between transmitter and receiver. If BSs of different classes are co-sited, the coupling loss must be increased by the difference between the corresponding values from the table above.

6.6.3.8 Protection of Public Safety Operations

This requirement shall be applied to BS operating in Bands XIII and XIV to ensure that appropriate interference protection is provided to 700 MHz public safety operations. This requirement is also applicable at specified frequencies falling between 12.5 MHz below the first carrier frequency used and 12.5 MHz above the last carrier frequency used.

6.6.3.8.1 Minimum Requirement

The power of any spurious emission shall not exceed:

Table 6.19: BS spurious emissions limits

Operating Band	Band	Maximum Level	Measurement Bandwidth	Note
XIII	763 - 775 MHz	-46 dBm	6.25 kHz	
XIII	793 - 805 MHz	-46 dBm	6.25 kHz	
XIV	769 - 775 MHz	-46 dBm	6.25 kHz	
XIV	799 - 805 MHz	-46 dBm	6.25 kHz	

6.6.3.9 Co-existence with Home BS operating in other bands

These requirements may be applied for the protection of Home BS receivers operating in other bands. These requirements are only applicable to Home BS.

6.6.3.9.1 Minimum Requirements

The power of any spurious emission shall not exceed the limits of Table 6.20 for a Home BS where requirements for co-existence with a Home BS type listed in the first column apply.

Table 6.20: Home BS Spurious emissions limits for co-existence with Home BS operating in other bands

Type of Home BS	Band for co-existence requirement	Maximum Level	Measurement Bandwidth	Note
UTRA FDD Band I	1920 - 1980 MHz	-82 dBm	100 kHz	
UTRA FDD Band II	1850 - 1910 MHz	-82 dBm	100 kHz	
UTRA FDD Band III	1710 - 1785 MHz	-82 dBm	100 kHz	
UTRA FDD Band IV	1710 - 1755 MHz	-82 dBm	100 kHz	
UTRA FDD Band V	824 - 849 MHz	-82 dBm	100 kHz	
UTRA FDD Band VI or XIX	815 - 850 MHz	-82 dBm	100 kHz	
UTRA FDD Band VII	2500 - 2570 MHz	-82 dBm	100 KHz	
UTRA FDD Band VIII	880 - 915 MHz	-82 dBm	100 KHz	
UTRA FDD Band IX	1749.9 - 1784.9 MHz	-82 dBm	100 KHz	
UTRA FDD Band X	1710 - 1770 MHz	-82 dBm	100 kHz	
UTRA FDD Band XI	1427.9 - 1447.9 MHz	-82 dBm	100 kHz	
UTRA FDD Band XII	698 - 716 MHz	-82 dBm	100 KHz	
UTRA FDD Band XIII	777 - 787 MHz	-82 dBm	100 kHz	
UTRA FDD Band XIV	788 - 798 MHz	-82 dBm	100 kHz	
UTRA FDD Band XXI	1447.9 - 1462.9 MHz	-82 dBm	100 kHz	

6.7 Transmit intermodulation

The transmit intermodulation performance is a measure of the capability of the transmitter to inhibit the generation of signals in its non linear elements caused by presence of the wanted signal and an interfering signal reaching the transmitter via the antenna.

The transmit intermodulation level is the power of the intermodulation products when a WCDMA modulated interference signal is injected into the antenna connector at a mean power level of 30 dB lower than that of the mean power of the wanted signal.

The interfering signal frequency offset from the subject signal carrier frequency shall be as in Table 6.21.

Table 6.21: Interfering signal frequency offset from the subject signal carrier frequency

Parameter	Value
Interfering signal frequency offset from the subject signal carrier frequency	-5 MHz -10 MHz -15 MHz +5 MHz +10 MHz +15 MHz
NOTE 1: Interference frequencies that are outside of the allocated frequency band for UTRA-FDD downlink specified in subclause 5.2 are excluded from the requirement, unless the interfering signal positions fall within the frequency range of adjacent downlink operating bands in the same geographical area.	
NOTE 2: NOTE 1 is not applied in Band I, VI, IX, XI, XIX, XXI in certain regions.	

6.7.1 Minimum requirement

The transmit intermodulation level shall not exceed the out of band emission or the spurious emission requirements of clauses 6.6.2 and 6.6.3 in the presence of a WCDMA modulated interference signal with a mean power level 30 dB lower than the mean power of the wanted signal.

6.8 Transmit modulation

Transmit modulation is specified in three parts, Frequency Error, Error Vector Magnitude and Peak Code Domain Error. These specifications are made with reference to a theoretical modulated waveform.

The theoretical modulated waveform is created by modulating a carrier at the assigned carrier frequency using the same data as was used to generate the measured waveform. The chip modulation rate for the theoretical waveform shall be exactly 3.84 Mcps. The code powers of the theoretical waveform shall be the same as the measured waveform, rather than the nominal code powers used to generate the test signal.

6.8.1 Transmit pulse shape filter

The transmit pulse-shaping filter is a root-raised cosine (RRC) with roll-off $\alpha = 0.22$ in the frequency domain. The impulse response of the chip impulse filter $RC_0(t)$ is

$$RC_0(t) = \frac{\sin\left(\pi \frac{t}{T_c}(1-\alpha)\right) + 4\alpha \frac{t}{T_c} \cos\left(\pi \frac{t}{T_c}(1+\alpha)\right)}{\pi \frac{t}{T_c} \left(1 - \left(4\alpha \frac{t}{T_c}\right)^2\right)}$$

Where the roll-off factor $\alpha = 0.22$ and the chip duration:

$$T_c = \frac{1}{\text{chiprate}} \approx 0.26042 \mu\text{s}$$

6.8.2 Error Vector Magnitude

The Error Vector Magnitude is a measure of the difference between the reference waveform and the measured waveform. This difference is called the error vector. Both waveforms pass through a matched Root Raised Cosine filter with bandwidth 3.84 MHz and roll-off $\alpha = 0.22$. Both waveforms are then further modified by selecting the frequency, absolute phase, absolute amplitude and chip clock timing so as to minimise the error vector. The EVM result is defined as the square root of the ratio of the mean error vector power to the mean reference power expressed as a %. The measurement interval is one timeslot as defined by the C-PICH (when present) otherwise the measurement interval is one timeslot starting with the beginning of the SCH. The requirement is valid over the total power dynamic range as specified in subclause 6.4.3.

6.8.2.1 Minimum requirement

The Error Vector Magnitude shall not be worse than 17.5 % when the base station is transmitting a composite signal using only QPSK modulation.

The Error Vector Magnitude shall not be worse than 12.5 % when the base station is transmitting a composite signal that includes 16QAM modulation.

6.8.3 Peak code Domain error

The Peak Code Domain Error is computed by projecting the error vector (as defined in 6.8.2) onto the code domain at a specified spreading factor. The Code Domain Error for every code in the domain is defined as the ratio of the mean power of the projection onto that code, to the mean power of the composite reference waveform. This ratio is expressed in dB. The Peak Code Domain Error is defined as the maximum value for the Code Domain Error for all codes. The measurement interval is one timeslot as defined by the C-PICH (when present) otherwise the measurement interval is one timeslot starting with the beginning of the SCH.

6.8.3.1 Minimum requirement

The peak code domain error shall not exceed -33 dB at spreading factor 256.

6.8.4 Time alignment error in Tx diversity, MIMO transmission, DC-HSDPA and DB-DC-HSDPA

In Tx diversity and MIMO transmission, signals are transmitted from two antennas. These signals shall be aligned. The time alignment error in Tx diversity and MIMO transmission is specified as the delay between the signals from the two diversity antennas at the antenna ports.

For dual cell transmissions (DC-HSDPA and DB-DC-HSDPA), the time alignment error is defined as the delay between the signals from the two cells at the antenna port(s).

For DC-HSDPA-MIMO, the time alignment error is defined as the maximum delay between any of the signals from the two cells at the antenna ports.

6.8.4.1 Minimum Requirement

The time alignment error in DC-HSDPA, Tx diversity or MIMO transmission shall not exceed $\frac{1}{4} T_c$.

The time alignment error in DB-DC-HSDPA shall not exceed $5 * T_c$.

The time alignment error in DC-HSDPA-MIMO transmission shall not exceed $\frac{1}{2} T_c$.

6.8.5 Relative Code Domain Error for 64QAM modulation

The Relative Code Domain Error is computed by projecting the error vector (as defined in 6.8.2) onto the code domain at a specified spreading factor. Only the active code channels in the composite reference waveform are considered for this requirement. The Relative Code Domain Error for every active code is defined as the ratio of the mean power of the error projection onto that code, to the mean power of the active code in the composite reference waveform. This ratio is expressed in dB. The measurement interval is one frame.

The requirement for Relative Code Domain Error is only applicable for 64QAM modulated codes.

6.8.5.1 Minimum requirement

The average Relative Code Domain Error for 64QAM modulated codes shall not exceed -21 dB at spreading factor 16.

7 Receiver characteristics

7.1 General

The requirements in clause 7 are expressed for a single receiver antenna connector. For receivers with antenna diversity, the requirements apply for each receiver antenna connector.

For ACS, blocking and intermodulation characteristics, the negative offsets of the interfering signal apply relative to the assigned channel frequency of the lowest carrier frequency used and positive offsets of the interfering signal apply relative to the assigned channel frequency of the highest carrier frequency used.

A BS supporting DC-HSUPA receives two cells simultaneously on adjacent carrier frequencies.

Unless otherwise stated, the receiver characteristics are specified at the BS antenna connector (test port A) with a full complement of transceivers for the configuration in normal operating conditions. If any external apparatus such as a RX amplifier, a filter or the combination of such devices is used, requirements apply at the far end antenna connector (port B).

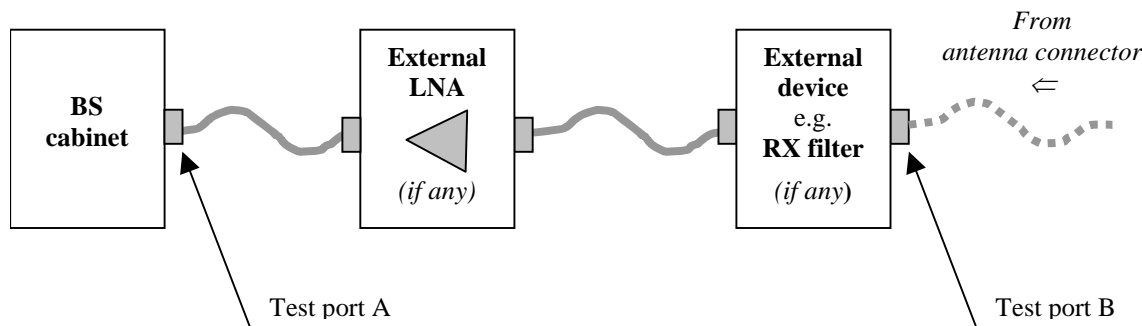

Figure 7.1: Receiver test ports

7.2 Reference sensitivity level

The reference sensitivity level is the minimum mean power received at the antenna connector at which the Bit Error Ratio (BER) shall not exceed the specific value indicated in section 7.2.1.

7.2.1 Minimum requirement

Using the reference measurement channel specification in Annex A, the reference sensitivity level and performance of the BS shall be as specified in Table 7.1.

Table 7.1: BS reference sensitivity levels

BS Class	Reference measurement channel data rate	BS reference sensitivity level (dBm)	BER
Wide Area BS	12.2 kbps	-121	BER shall not exceed 0.001
Medium Range BS	12.2 kbps	-111	BER shall not exceed 0.001
Local Area / Home BS	12.2 kbps	-107	BER shall not exceed 0.001

7.2.2 Maximum Frequency Deviation for Receiver Performance

The need for such a requirement is for further study.

7.3 Dynamic range

Receiver dynamic range is the receiver ability to handle a rise of interference in the reception frequency channel. The receiver shall fulfil a specified BER requirement for a specified sensitivity degradation of the wanted signal in the presence of an interfering AWGN signal in the same reception frequency channel.

7.3.1 Minimum requirement

The BER shall not exceed 0.001 for the parameters specified in Table 7.2.

Table 7.2: Dynamic range

Parameter	Level Wide Area BS	Level Medium Range BS	Level Local Area / Home BS	Level Home BS ¹	Unit
Reference measurement channel data rate	12.2	12.2	12.2	12.2	kbps
Wanted signal mean power	-91	-81	-77	-57	dBm
Interfering AWGN signal	-73	-63	-59	-39	dBm/3.84 MHz

Note 1: For Home BS, this additional requirement ensures the performance is met over a large dynamic range.

7.4 Adjacent Channel Selectivity (ACS)

Adjacent channel selectivity (ACS) is a measure of the receiver ability to receive a wanted signal at its assigned channel frequency in the presence of an adjacent channel signal at a given frequency offset from the center frequency of the assigned channel. ACS is the ratio of the receiver filter attenuation on the assigned channel frequency to the receiver filter attenuation on the adjacent channel(s).

The interference signal is offset from the wanted signal by the frequency offset F_{uw} . The interference signal shall be a W-CDMA signal as specified in Annex C.

7.4.1 Minimum requirement

The BER shall not exceed 0.001 for the parameters specified in Table 7.3.

Table 7.3: Adjacent channel selectivity

Parameter	Level Wide Area BS	Level Medium Range BS	Level Local Area / Home BS	Level Home BS ¹	Unit
Data rate	12.2	12.2	12.2	12.2	kbps
Wanted signal mean power	-115	-105	-101	-91	dBm
Interfering signal mean power	-52	-42	-38	-28	dBm
Fuw offset (Modulated)	±5	±5	±5	±5	MHz
Note 1: For Home BS, this additional requirement ensures the performance is met over a large dynamic range.					

7.4.2 Minimum requirement - Co-location with UTRA-TDD

The current state-of-the-art technology does not allow a single generic solution for co-location with UTRA-TDD on adjacent frequencies for 30dB BS-BS minimum coupling loss.

Further information and analysis for this scenario can be found in TR 25.942 [4].

7.5 Blocking characteristics

The blocking characteristics are measure of the receiver ability to receive a wanted signal at its assigned channel frequency in the presence of an unwanted interferer on frequencies other than those of the adjacent channels. The blocking performance requirement applies as specified in the tables 7.4 to 7.5B below, using a 1 MHz step size.

NOTE: The minimum requirements for Home BS when co-located with DECT and WiFi/WLAN are FFS.

7.5.1 Minimum requirement

The static reference performance as specified in clause 7.2.1 shall be met with a wanted and an interfering signal coupled to BS antenna input using the following parameters.

Table 7.4: Blocking performance requirement for Wide Area BS

Operating Band	Center Frequency of Interfering Signal	Interfering Signal mean power	Wanted Signal mean power	Minimum Offset of Interfering Signal	Type of Interfering Signal
I	1920 - 1980 MHz	-40 dBm	-115 dBm	±10 MHz	WCDMA signal *
	1900 - 1920 MHz 1980 - 2000 MHz	-40 dBm	-115 dBm	±10 MHz	WCDMA signal *
	1 MHz - 1900 MHz 2000 MHz - 12750 MHz	-15 dBm	-115 dBm	—	CW carrier
II	1850 - 1910 MHz	-40 dBm	-115 dBm	±10 MHz	WCDMA signal *
	1830 - 1850 MHz 1910 - 1930 MHz	-40 dBm	-115 dBm	±10 MHz	WCDMA signal *
	1 MHz - 1830 MHz 1930 MHz - 12750 MHz	-15 dBm	-115 dBm	—	CW carrier
III	1710 - 1785 MHz	-40 dBm	-115 dBm	±10 MHz	WCDMA signal *
	1690 - 1710 MHz 1785 - 1805 MHz	-40 dBm	-115 dBm	±10 MHz	WCDMA signal *
	1 MHz - 1690 MHz 1805 MHz - 12750 MHz	-15 dBm	-115 dBm	—	CW carrier
IV	1710 - 1755 MHz	-40 dBm	-115 dBm	±10 MHz	WCDMA signal *
	1690 - 1710 MHz 1755 - 1775 MHz	-40 dBm	-115 dBm	±10 MHz	WCDMA signal *
	1 MHz - 1690 MHz 1775 MHz - 12750 MHz	-15 dBm	-115 dBm	—	CW carrier
V	824-849 MHz	-40 dBm	-115 dBm	±10 MHz	WCDMA signal *
	804-824 MHz 849-869 MHz	-40 dBm	-115 dBm	±10 MHz	WCDMA signal *
	1 MHz - 804 MHz 869 MHz - 12750 MHz	-15 dBm	-115 dBm	—	CW carrier
VI	810 - 830 MHz 840 - 860 MHz	-40 dBm	-115 dBm	±10 MHz	WCDMA signal *
	1 MHz - 810 MHz 860 MHz - 12750 MHz	-15 dBm	-115 dBm	—	CW carrier
	2500 - 2570 MHz	-40 dBm	-115 dBm	±10 MHz	WCDMA signal *
VII	2480 - 2500 MHz 2570 - 2590 MHz	-40 dBm	-115 dBm	±10 MHz	WCDMA signal *
	1 MHz - 2480 MHz 2590 MHz - 12750 MHz	-15 dBm	-115 dBm	—	CW carrier
	880 - 915 MHz	-40 dBm	-115 dBm	±10 MHz	WCDMA signal *
VIII	860 - 880 MHz 915 - 925 MHz	-40 dBm	-115 dBm	±10 MHz	WCDMA signal *
	1 MHz - 860 MHz 925 MHz - 12750 MHz	-15 dBm	-115 dBm	—	CW carrier
	1749.9 - 1784.9 MHz	-40 dBm	-115 dBm	±10 MHz	WCDMA signal *
IX	1729.9 - 1749.9 MHz 1784.9 - 1804.9 MHz	-40 dBm	-115 dBm	±10 MHz	WCDMA signal *
	1 MHz - 1729.9 MHz 1804.9 MHz - 12750 MHz	-15 dBm	-115 dBm	—	CW carrier
	1710 - 1770 MHz	-40 dBm	-115 dBm	±10 MHz	WCDMA signal *
X	1690 - 1710 MHz 1770 - 1790 MHz	-40 dBm	-115 dBm	±10 MHz	WCDMA signal *
	1 MHz - 1690 MHz 1790 MHz - 12750 MHz	-15 dBm	-115 dBm	—	CW carrier
	1427.9 - 1447.9 MHz	-40 dBm	-115 dBm	±10 MHz	WCDMA signal *
XI	1407.9 - 1427.9 MHz 1447.9 - 1467.9 MHz	-40 dBm	-115 dBm	±10 MHz	WCDMA signal *

	1 MHz - 1407.9 MHz 1467.9 MHz - 12750 MHz	-15 dBm	-115 dBm	—	CW carrier
XII	698 - 716 MHz	-40 dBm	-115 dBm	± 10 MHz	WCDMA signal *
	678 - 698 MHz 716 - 728 MHz	-40 dBm	-115 dBm	± 10 MHz	WCDMA signal *
	1 MHz - 678 MHz 728 MHz - 12750 MHz	-15 dBm	-115 dBm	—	CW carrier
XIII	777 - 787 MHz	-40 dBm	-115 dBm	± 10 MHz	WCDMA signal *
	757 - 777 MHz 787 - 807 MHz	-40 dBm	-115 dBm	± 10 MHz	WCDMA signal *
	1 - 757 MHz 807 MHz - 12750 MHz	-15 dBm	-115 dBm	—	CW carrier
XIV	788 - 798 MHz	-40 dBm	-115 dBm	± 10 MHz	WCDMA signal *
	768 - 788 MHz 798 - 818 MHz	-40 dBm	-115 dBm	± 10 MHz	WCDMA signal *
	1 - 768 MHz 818 MHz - 12750 MHz	-15 dBm	-115 dBm	—	CW carrier
XIX	830 - 845 MHz	-40 dBm	-115 dBm	± 10 MHz	WCDMA signal *
	810 - 830 MHz 845 - 865 MHz	-40 dBm	-115 dBm	± 10 MHz	WCDMA signal *
	1 MHz - 810 MHz 865 MHz - 12750 MHz	-15 dBm	-115 dBm	—	CW carrier
XXI	1447.9 - 1462.9 MHz	-40 dBm	-115 dBm	± 10 MHz	WCDMA signal *
	1427.9 - 1447.9 MHz 1462.9 - 1482.9 MHz	-40 dBm	-115 dBm	± 10 MHz	WCDMA signal *
	1 MHz - 1427.9 MHz 1482.9 MHz - 12750 MHz	-15 dBm	-115 dBm	—	CW carrier
NOTE *: The characteristics of the W-CDMA interference signal are specified in Annex C.					

Table 7.4A: Blocking performance requirement for Medium range BS

Operating Band	Center Frequency of Interfering Signal	Interfering Signal mean power	Wanted Signal mean power	Minimum Offset of Interfering Signal	Type of Interfering Signal
I	1920 - 1980 MHz	-35 dBm	-105 dBm	± 10 MHz	WCDMA signal *
	1900 - 1920 MHz 1980 - 2000 MHz	-35 dBm	-105 dBm	± 10 MHz	WCDMA signal *
	1 MHz - 1900 MHz 2000 MHz - 12750 MHz	-15 dBm	-105 dBm	—	CW carrier
II	1850 - 1910 MHz	-35 dBm	-105 dBm	± 10 MHz	WCDMA signal *
	1830 - 1850 MHz 1910 - 1930 MHz	-35 dBm	-105 dBm	± 10 MHz	WCDMA signal *
	1 MHz - 1830 MHz 1930 MHz - 12750 MHz	-15 dBm	-105 dBm	—	CW carrier
III	1710 - 1785 MHz	-35 dBm	-105 dBm	± 10 MHz	WCDMA signal *
	1690 - 1710 MHz 1785 - 1805 MHz	-35 dBm	-105 dBm	± 10 MHz	WCDMA signal *
	1 MHz - 1690 MHz 1805 MHz - 12750 MHz	-15 dBm	-105 dBm	—	CW carrier
IV	1710 - 1755 MHz	-35 dBm	-105 dBm	± 10 MHz	WCDMA signal *
	1690 - 1710 MHz 1755 - 1775 MHz	-35 dBm	-105 dBm	± 10 MHz	WCDMA signal *
	1 MHz - 1690 MHz 1775 MHz - 12750 MHz	-15 dBm	-105 dBm	—	CW carrier
V	824-849 MHz	-35 dBm	-105 dBm	± 10 MHz	WCDMA signal *
	804-824 MHz 849-869 MHz	-35 dBm	-105 dBm	± 10 MHz	WCDMA signal *
	1 MHz - 804 MHz 869 MHz - 12750 MHz	-15 dBm	-105 dBm	—	CW carrier
VI	810 - 830 MHz 840 - 860 MHz	-35 dBm	-105 dBm	± 10 MHz	WCDMA signal *
	1 MHz - 810 MHz 860 MHz - 12750 MHz	-15 dBm	-105 dBm	—	CW carrier
VII	2500 - 2570 MHz	-35 dBm	-105 dBm	± 10 MHz	WCDMA signal *
	2480 - 2500 MHz 2570 - 2590 MHz	-35 dBm	-105 dBm	± 10 MHz	WCDMA signal *
	1 MHz - 2480 MHz 2590 MHz - 12750 MHz	-15 dBm	-105 dBm	—	CW carrier
VIII	880 - 915 MHz	-35 dBm	-105 dBm	± 10 MHz	WCDMA signal *
	860 - 880 MHz 915 - 925 MHz	-35 dBm	-105 dBm	± 10 MHz	WCDMA signal *
	1 MHz - 860 MHz 925 MHz - 12750 MHz	-15 dBm	-105 dBm	—	CW carrier
IX	1749.9 - 1784.9 MHz	-35 dBm	-105 dBm	± 10 MHz	WCDMA signal *
	1729.9 - 1749.9 MHz 1784.9 - 1804.9 MHz	-35 dBm	-105 dBm	± 10 MHz	WCDMA signal *
	1 MHz - 1729.9 MHz 1804.9 MHz - 12750 MHz	-15 dBm	-105 dBm	—	CW carrier
X	1710 - 1770 MHz	-35 dBm	-105 dBm	± 10 MHz	WCDMA signal *
	1690 - 1710 MHz 1770 - 1790 MHz	-35 dBm	-105 dBm	± 10 MHz	WCDMA signal *
	1 MHz - 1690 MHz 1790 MHz - 12750 MHz	-15 dBm	-105 dBm	—	CW carrier
XI	1427.9 - 1447.9 MHz	-35 dBm	-105 dBm	± 10 MHz	WCDMA signal *
	1407.9 - 1427.9 MHz 1447.9 - 1467.9 MHz	-35 dBm	-105 dBm	± 10 MHz	WCDMA signal *
	1 MHz - 1407.9 MHz 1467.9 MHz - 12750 MHz	-15 dBm	-105 dBm	—	CW carrier
XII	698 - 716 MHz	-35dBm	-105 dBm	± 10 MHz	WCDMA signal *
	678 - 698 MHz 716 - 728 MHz	-35 dBm	-105 dBm	± 10 MHz	WCDMA signal *
	1 MHz - 678 MHz 728 MHz – 12750 MHz	-15 dBm	-105 dBm	—	CW carrier

XIII	777 - 787 MHz	-35 dBm	-105 dBm	± 10 MHz	WCDMA signal *
	757 - 777 MHz 787 - 807 MHz	-35 dBm	-105 dBm	± 10 MHz	WCDMA signal *
	1 - 757 MHz 807 MHz - 12750 MHz	-15 dBm	-105 dBm	—	CW carrier
XIV	788 - 798 MHz	-35 dBm	-105 dBm	± 10 MHz	WCDMA signal *
	768 - 788 MHz 798 - 818 MHz	-35 dBm	-105 dBm	± 10 MHz	WCDMA signal *
	1 - 768 MHz 818 MHz - 12750 MHz	-15 dBm	-105 dBm	—	CW carrier
XIX	830 - 845 MHz	-35 dBm	-105 dBm	± 10 MHz	WCDMA signal *
	810 - 830 MHz 845 - 865 MHz	-35 dBm	-105 dBm	± 10 MHz	WCDMA signal *
	1 MHz - 810 MHz 865 MHz - 12750 MHz	-15 dBm	-105 dBm	—	CW carrier
XXI	1447.9 - 1462.9 MHz	-35 dBm	-105 dBm	± 10 MHz	WCDMA signal *
	1427.9 - 1447.9 MHz 1462.9 - 1482.9 MHz	-35 dBm	-105 dBm	± 10 MHz	WCDMA signal *
	1 MHz - 1427.9 MHz 1482.9 MHz - 12750 MHz	-15 dBm	-105 dBm	—	CW carrier
NOTE *: The characteristics of the W-CDMA interference signal are specified in Annex C.					

Table 7.4B: Blocking performance requirement for Local Area / Home BS

Operating Band	Center Frequency of Interfering Signal	Interfering Signal mean power	Wanted Signal mean power	Minimum Offset of Interfering Signal	Type of Interfering Signal
I	1920 - 1980 MHz	-30 dBm	-101 dBm	±10 MHz	WCDMA signal *
	1900 - 1920 MHz 1980 - 2000 MHz	-30 dBm	-101 dBm	±10 MHz	WCDMA signal *
	1 MHz - 1900 MHz 2000 MHz - 12750 MHz	-15 dBm	-101 dBm	—	CW carrier
II	1850 - 1910 MHz	-30 dBm	-101 dBm	±10 MHz	WCDMA signal *
	1830 - 1850 MHz 1910 - 1930 MHz	-30 dBm	-101 dBm	±10 MHz	WCDMA signal *
	1 MHz - 1830 MHz 1930 MHz - 12750 MHz	-15 dBm	-101 dBm	—	CW carrier
III	1710 - 1785 MHz	-30 dBm	-101 dBm	±10 MHz	WCDMA signal *
	1690 - 1710 MHz 1785 - 1805 MHz	-30 dBm	-101 dBm	±10 MHz	WCDMA signal *
	1 MHz - 1690 MHz 1805 MHz - 12750 MHz	-15 dBm	-101 dBm	—	CW carrier
IV	1710 - 1755 MHz	-30 dBm	-101 dBm	±10 MHz	WCDMA signal *
	1690 - 1710 MHz 1755 - 1775 MHz	-30 dBm	-101 dBm	±10 MHz	WCDMA signal *
	1 MHz - 1690 MHz 1775 MHz - 12750 MHz	-15 dBm	-101 dBm	—	CW carrier
V	824-849 MHz	-30 dBm	-101 dBm	±10 MHz	WCDMA signal *
	804-824 MHz 849-869 MHz	-30 dBm	-101 dBm	±10 MHz	WCDMA signal *
	1 MHz - 804 MHz 869 MHz - 12750 MHz	-15 dBm	-101 dBm	—	CW carrier
VI	810 - 830 MHz 840 - 860 MHz	-30 dBm	-101 dBm	±10 MHz	WCDMA signal *
	1 MHz - 810 MHz 860 MHz - 12750 MHz	-15 dBm	-101 dBm	—	CW carrier
VII	2500 - 2570 MHz	-30 dBm	-101 dBm	±10 MHz	WCDMA signal *
	2480 - 2500 MHz 2570 - 2590 MHz	-30 dBm	-101 dBm	±10 MHz	WCDMA signal *
	1 MHz - 2480 MHz 2590 MHz - 12750 MHz	-15 dBm	-101 dBm	—	CW carrier
VIII	880 - 915 MHz	-30 dBm	-101 dBm	±10 MHz	WCDMA signal *
	860 - 880 MHz 915 - 925 MHz	-30 dBm	-101 dBm	±10 MHz	WCDMA signal *
	1 MHz - 860 MHz 925 MHz - 12750 MHz	-15 dBm	-101 dBm	—	CW carrier
IX	1749.9 - 1784.9 MHz	-30 dBm	-101 dBm	±10 MHz	WCDMA signal *
	1729.9 - 1749.9 MHz 1784.9 - 1804.9 MHz	-30 dBm	-101 dBm	±10 MHz	WCDMA signal *
	1 MHz - 1729.9 MHz 1804.9 MHz - 12750 MHz	-15 dBm	-101 dBm	—	CW carrier
X	1710 - 1770 MHz	-30 dBm	-101 dBm	±10 MHz	WCDMA signal *
	1690 - 1710 MHz 1770 - 1790 MHz	-30 dBm	-101 dBm	±10 MHz	WCDMA signal *
	1 MHz - 1690 MHz 1790 MHz - 12750 MHz	-15 dBm	-101 dBm	—	CW carrier
XI	1427.9 - 1447.9 MHz	-30 dBm	-101 dBm	±10 MHz	WCDMA signal *
	1407.9 - 1427.9 MHz 1447.9 - 1467.9 MHz	-30 dBm	-101 dBm	±10 MHz	WCDMA signal *
	1 MHz - 1407.9 MHz 1467.9 MHz - 12750 MHz	-15 dBm	-101 dBm	—	CW carrier
XII	698 - 716 MHz	-30 dBm	-101 dBm	±10 MHz	WCDMA signal *
	678 - 698 MHz 716 - 728 MHz	-30 dBm	-101 dBm	±10 MHz	WCDMA signal *
	1 MHz - 678 MHz 728 MHz - 12750 MHz	-15 dBm	-101 dBm	—	CW carrier

XIII	777 - 787 MHz	-30 dBm	-101 dBm	±10 MHz	WCDMA signal *
	757 - 777 MHz 787 - 807 MHz	-30 dBm	-101 dBm	±10 MHz	WCDMA signal *
	1 - 757 MHz 807 MHz - 12750 MHz	-15 dBm	-101 dBm	—	CW carrier
XIV	788 - 798 MHz	-30 dBm	-101 dBm	±10 MHz	WCDMA signal *
	768 - 788 MHz 798 - 818 MHz	-30 dBm	-101 dBm	±10 MHz	WCDMA signal *
	1 - 768 MHz 818 MHz - 12750 MHz	-15 dBm	-101 dBm	—	CW carrier
XIX	830 - 845 MHz	-30 dBm	-101 dBm	±10 MHz	WCDMA signal *
	810 - 830 MHz 845 - 865 MHz	-30 dBm	-101 dBm	±10 MHz	WCDMA signal *
	1 MHz - 810 MHz 865 MHz - 12750 MHz	-15 dBm	-101 dBm	—	CW carrier
XXI	1447.9 - 1462.9 MHz	-30 dBm	-101 dBm	±10 MHz	WCDMA signal *
	1427.9 - 1447.9 MHz 1462.9 - 1482.9 MHz	-30 dBm	-101 dBm	±10 MHz	WCDMA signal *
	1 MHz - 1427.9 MHz 1482.9 MHz - 12750 MHz	-15 dBm	-101 dBm	—	CW carrier

NOTE *: The characteristics of the W-CDMA interference signal are specified in Annex C.

Table 7.5: Blocking performance requirement (narrowband) for Wide Area BS

Operating Band	Center Frequency of Interfering Signal	Interfering Signal mean power	Wanted Signal mean power	Minimum Offset of Interfering Signal	Type of Interfering Signal
II	1850 - 1910 MHz	- 47 dBm	-115 dBm	±2.7 MHz	GMSK modulated*
III	1710 - 1785 MHz	- 47 dBm	-115 dBm	±2.8 MHz	GMSK modulated*
IV	1710 - 1755 MHz	- 47 dBm	-115 dBm	±2.7 MHz	GMSK modulated*
V	824 - 849 MHz	- 47 dBm	-115 dBm	±2.7 MHz	GMSK modulated*
VIII	880 - 915 MHz	- 47 dBm	-115 dBm	±2.8 MHz	GMSK modulated*
X	1710 - 1770 MHz	- 47 dBm	-115 dBm	±2.7 MHz	GMSK modulated*
XII	698 - 716 MHz	- 47 dBm	-115 dBm	±2.7 MHz	GMSK modulated*
XIII	777 - 787 MHz	- 47 dBm	-115 dBm	±2.7 MHz	GMSK modulated*
XIV	788 - 798 MHz	- 47 dBm	-115 dBm	±2.7 MHz	GMSK modulated*

NOTE *: GMSK modulation as defined in TS 45.004 [5].

Table 7.5A: Blocking performance requirement (narrowband) for Medium Range BS

Operating Band	Center Frequency of Interfering Signal	Interfering Signal mean power	Wanted Signal mean power	Minimum Offset of Interfering Signal	Type of Interfering Signal
II	1850 - 1910 MHz	- 42 dBm	-105 dBm	±2.7 MHz	GMSK modulated*
III	1710 - 1785 MHz	- 42 dBm	-105 dBm	±2.8 MHz	GMSK modulated*
IV	1710 - 1755 MHz	- 42 dBm	-105 dBm	±2.7 MHz	GMSK modulated*
V	824 - 849 MHz	- 42 dBm	-105 dBm	±2.7 MHz	GMSK modulated*
VIII	880 - 915 MHz	- 42 dBm	-105 dBm	±2.8 MHz	GMSK modulated*
X	1710 - 1770 MHz	- 42 dBm	-105 dBm	±2.7 MHz	GMSK modulated*
XII	698 - 716 MHz	- 42 dBm	-105 dBm	±2.7 MHz	GMSK modulated*
XIII	777 - 787 MHz	- 42 dBm	-105 dBm	±2.7 MHz	GMSK modulated*
XIV	788 - 798 MHz	- 42 dBm	-105 dBm	±2.7 MHz	GMSK modulated*

NOTE *: GMSK modulation as defined in TS 45.004 [5].

Table 7.5B: Blocking performance requirement (narrowband) for Local Area / Home BS

Operating Band	Center Frequency of Interfering Signal	Interfering Signal mean power	Wanted Signal mean power	Minimum Offset of Interfering Signal	Type of Interfering Signal
II	1850 - 1910 MHz	- 37 dBm	-101 dBm	±2.7 MHz	GMSK modulated*
III	1710 - 1785 MHz	- 37 dBm	-101 dBm	±2.8 MHz	GMSK modulated*
IV	1710 - 1755 MHz	- 37 dBm	-101 dBm	±2.7 MHz	GMSK modulated*
V	824 - 849 MHz	- 37 dBm	-101 dBm	±2.7 MHz	GMSK modulated*
VIII	880 - 915 MHz	- 37 dBm	-101 dBm	±2.8 MHz	GMSK modulated*
X	1710 - 1770 MHz	- 37 dBm	-101 dBm	±2.7 MHz	GMSK modulated*
XII	698 - 716 MHz	- 37 dBm	-101 dBm	±2.7 MHz	GMSK modulated*
XIII	777 - 787 MHz	- 37 dBm	-101 dBm	±2.7 MHz	GMSK modulated*
XIV	788 - 798 MHz	- 37 dBm	-101 dBm	±2.7 MHz	GMSK modulated*
NOTE *: GMSK modulation as defined in TS 45.004 [5].					

7.5.2 Minimum Requirement - Co-location with GSM900, DCS 1800, PCS1900, GSM850, UTRA FDD and/or E-UTRA FDD

This additional blocking requirement may be applied for the protection of FDD BS receivers when GSM900, DCS1800, PCS1900, GSM850, UTRA FDD BS and/or E-UTRA FDD are co-located with a UTRA FDD BS.

The requirements in this chapter assume a 30 dB coupling loss between transmitter and receiver. If BSs of different classes are co-sited, the coupling loss should be increased by the value as stated in TR 25.942 [4] chapter 10.3 in Table 10.1 and Table 10.2.

For a Wide Area (WA) FDD BS, the static reference performance as specified in clause 7.2.1 shall be met with a wanted and an interfering signal coupled to BS antenna input using the parameters in Table 7.5C.

Table 7.5C: Blocking performance requirement for Wide Area BS when co-located with BS in other bands.

Co-located BS type	Center Frequency of Interfering Signal	Interfering Signal mean power	Wanted Signal mean power	Type of Interfering Signal
Macro GSM900	921 - 960 MHz	+16 dBm	-115 dBm	CW carrier
Macro DCS1800	1805 - 1880 MHz	+16 dBm	-115 dBm	CW carrier
Macro PCS1900	1930 - 1990 MHz	+16 dBm	-115 dBm	CW carrier
Macro GSM850 or CDMA850	869 - 894 MHz	+16 dBm	-115 dBm	CW carrier
WA UTRA-FDD Band I or E-UTRA Band 1	2110 - 2170 MHz	+16 dBm	-115 dBm	CW carrier
WA UTRA-FDD Band II or E-UTRA Band 2	1930 - 1990 MHz	+16 dBm	-115 dBm	CW carrier
WA UTRA-FDD Band III or E-UTRA Band 3	1805 - 1880 MHz	+16 dBm	-115 dBm	CW carrier
WA UTRA-FDD Band IV or E-UTRA Band 4	2110 - 2155 MHz	+16 dBm	-115 dBm	CW carrier
WA UTRA-FDD Band V or E-UTRA Band 5	869 - 894 MHz	+16 dBm	-115 dBm	CW carrier
WA UTRA-FDD Band VI or E-UTRA Band 6	875 - 885 MHz	+16 dBm	-115 dBm	CW carrier
WA UTRA-FDD Band VII or E-UTRA Band 7	2620 - 2690 MHz	+16 dBm	-115 dBm	CW carrier
WA UTRA-FDD Band VIII or E-UTRA Band 8	925 - 960 MHz	+16 dBm	-115 dBm	CW carrier
WA UTRA-FDD Band IX or E-UTRA Band 9	1844.9 - 1879.9 MHz	+16 dBm	-115 dBm	CW carrier
WA UTRA-FDD Band X or E-UTRA Band 10	2110 - 2170 MHz	+16 dBm	-115 dBm	CW carrier
WA UTRA-FDD Band XI or E-UTRA Band 11	1475.9 – 1495.9 MHz	+16 dBm	-115 dBm	CW carrier
WA UTRA-FDD Band XII or E-UTRA Band 12	728 - 746 MHz	+16 dBm	-115 dBm	CW carrier
WA UTRA-FDD Band XIII or E-UTRA Band 13	746 - 756 MHz	+16 dBm	-115 dBm	CW carrier
WA UTRA-FDD Band XIV or E-UTRA Band 14	758 - 768 MHz	+16 dBm	-115 dBm	CW carrier
E-UTRA Band 17	734 - 746 MHz	+16 dBm	-115 dBm	CW carrier
E-UTRA Band 18	860 – 875 MHz	+16 dBm	-115 dBm	CW carrier
WA UTRA-FDD Band XIX or E-UTRA Band 19	875 - 890 MHz	+16 dBm	-115 dBm	CW carrier
WA UTRA-FDD Band XXI	1495.9 – 1510.9 MHz	+16 dBm	-115 dBm	CW carrier

For a Medium Range (MR) FDD BS, the static reference performance as specified in clause 7.2.1 shall be met with a wanted and an interfering signal coupled to BS antenna input using the parameters in Table 7.5D.

Table 7.5D: Blocking performance requirement for Medium Range BS when co-located with BS in other bands.

Co-located BS type	Center Frequency of Interfering Signal	Interfering Signal mean power	Wanted Signal mean power	Type of Interfering Signal
Micro GSM900	921 - 960 MHz	-3 dBm	-105 dBm	CW carrier
Micro DCS1800	1805 - 1880 MHz	+5 dBm	-105 dBm	CW carrier
Micro PCS1900	1930 - 1990 MHz	+5 dBm	-105 dBm	CW carrier
Micro GSM850	869 - 894 MHz	-3 dBm	-105 dBm	CW carrier
MR UTRA-FDD Band I	2110 - 2170 MHz	+8 dBm	-105 dBm	CW carrier
MR UTRA-FDD Band II	1930 - 1990 MHz	+8 dBm	-105 dBm	CW carrier
MR UTRA-FDD Band III	1805 - 1880 MHz	+8 dBm	-105 dBm	CW carrier
MR UTRA-FDD Band IV	2110 - 2155 MHz	+8 dBm	-105 dBm	CW carrier
MR UTRA-FDD Band V	869 - 894 MHz	+8 dBm	-105 dBm	CW carrier
MR UTRA-FDD Band VI	875 - 885 MHz	+8 dBm	-105 dBm	CW carrier
MR UTRA-FDD Band VII	2620 - 2690 MHz	+8 dBm	-105 dBm	CW carrier
MR UTRA-FDD Band VIII	925 - 960 MHz	+8 dBm	-105 dBm	CW carrier
MR UTRA-FDD Band IX	1844.9 - 1879.9 MHz	+8 dBm	-105 dBm	CW carrier
MR UTRA-FDD Band X	2110 - 2170 MHz	+8 dBm	-105 dBm	CW carrier
MR UTRA-FDD Band XI	1475.9 - 1495.9 MHz	+8 dBm	-105 dBm	CW carrier
MR UTRA-FDD Band XII	728 - 746 MHz	+8 dBm	-105 dBm	CW carrier
MR UTRA-FDD Band XIII	746 - 756 MHz	+8 dBm	-105 dBm	CW carrier
MR UTRA-FDD Band XIV	758 - 768 MHz	+8 dBm	-105 dBm	CW carrier
MR UTRA-FDD Band XIX	875 - 890 MHz	+8 dBm	-105 dBm	CW carrier
MR UTRA-FDD Band XXI	1495.9 - 1510.9 MHz	+8 dBm	-105 dBm	CW carrier

For a Local Area (LA) FDD BS, the static reference performance as specified in clause 7.2.1 shall be met with a wanted and an interfering signal coupled to BS antenna input using the parameters in Table 7.5E.

Table 7.5E: Blocking performance requirement for Local Area BS when co-located with BS in other bands.

Co-located BS type	Center Frequency of Interfering Signal	Interfering Signal mean power	Wanted Signal mean power	Type of Interfering Signal
Pico GSM900	921 - 960 MHz	-7 dBm	-101 dBm	CW carrier
Pico DCS1800	1805 - 1880 MHz	-4 dBm	-101 dBm	CW carrier
Pico PCS1900	1930 - 1990 MHz	-4 dBm	-101 dBm	CW carrier
Pico GSM850	869 - 894 MHz	-7dBm	-101 dBm	CW carrier
LA UTRA-FDD Band I	2110 - 2170 MHz	-6 dBm	-101 dBm	CW carrier
LA UTRA-FDD Band II	1930 - 1990 MHz	-6 dBm	-101 dBm	CW carrier
LA UTRA-FDD Band III	1805 - 1880 MHz	-6 dBm	-101 dBm	CW carrier
LA UTRA-FDD Band IV	2110 - 2155 MHz	-6 dBm	-101 dBm	CW carrier
LA UTRA-FDD Band V	869 - 894 MHz	-6 dBm	-101 dBm	CW carrier
LA UTRA-FDD Band VI	875 - 885 MHz	-6 dBm	-101 dBm	CW carrier
LA UTRA-FDD Band VII	2620 - 2690 MHz	-6 dBm	-101 dBm	CW carrier
LA UTRA-FDD Band VIII	925 - 960 MHz	-6 dBm	-101 dBm	CW carrier
LA UTRA-FDD Band IX	1844.9 - 1879.9 MHz	-6 dBm	-101 dBm	CW carrier
LA UTRA-FDD Band X	2110 - 2170 MHz	-6 dBm	-101 dBm	CW carrier
LA UTRA-FDD Band XI	1475.9 - 1495.9 MHz	-6 dBm	-101 dBm	CW carrier
LA UTRA-FDD Band XII	728 - 746 MHz	-6 dBm	-101 dBm	CW carrier
LA UTRA-FDD Band XIII	746 - 756 MHz	-6 dBm	-101 dBm	CW carrier
LA UTRA-FDD Band XIV	758 - 768 MHz	-6 dBm	-101 dBm	CW carrier
LA UTRA-FDD Band XIX	875 - 890 MHz	-6 dBm	-101 dBm	CW carrier
LA UTRA-FDD Band XXI	1495.9 - 1510.9 MHz	-6 dBm	-101 dBm	CW carrier

7.5.3 Minimum Requirement - Co-location with UTRA-TDD

An additional blocking requirement may be applied for the protection of FDD BS receivers when UTRA TDD is co-located with a UTRA FDD BS.

The requirements in this chapter assume a 30 dB coupling loss between transmitter and receiver. If BSs of different classes are co sited, the coupling loss should be increased by the value as stated in TR 25.942 [4] chapter 10.3 in Table 10.1 and Table 10.2.

The current state-of-the-art technology does not allow a single generic solution for co-location with UTRA-TDD on adjacent frequencies for 30dB BS-BS minimum coupling loss.

However, there are certain site-engineering solutions that can be used in these cases. These techniques are addressed in TR 25.942 [4].

For a Wide Area (WA) FDD BS, the static reference performance as specified in clause 7.2.1 should be met with a wanted and an interfering signal coupled to BS antenna input using the parameters in Table 7.5F.

Table 7.5F: Blocking performance requirement for Wide Area BS when co-located with UTRA TDD BS in other bands.

Co-located BS type	Center Frequency of Interfering Signal	Interfering Signal mean power	Wanted Signal mean power	Type of Interfering Signal
Wide Area TDD	2585 - 2620 MHz	+16 dBm	-115 dBm	CW carrier

For a Local Area (LA) FDD BS, the static reference performance as specified in clause 7.2.1 should be met with a wanted and an interfering signal coupled to BS antenna input using the parameters in Table 7.5G.

Table 7.5G: Blocking performance requirement for Local Area BS when co-located with UTRA TDD BS in other bands.

Co-located BS type	Center Frequency of Interfering Signal	Interfering Signal mean power	Wanted Signal mean power	Type of Interfering Signal
Local Area TDD	2585 - 2620 MHz	-4 dBm	-101 dBm	CW carrier

7.6 Intermodulation characteristics

Third and higher order mixing of the two interfering RF signals can produce an interfering signal in the band of the desired channel. Intermodulation response rejection is a measure of the capability of the receiver to receive a wanted signal on its assigned channel frequency in the presence of two or more interfering signals which have a specific frequency relationship to the wanted signal.

7.6.1 Minimum requirement

The static reference performance as specified in clause 7.2.1 shall be met for a Wide Area BS when the following signals are coupled to BS antenna input:

- A wanted signal at the assigned channel frequency with a mean power of -115 dBm.
- Two interfering signals with the following parameters.

Table 7.6: Intermodulation performance requirement (Wide Area BS)

Operating band	Interfering Signal mean power	Offset	Type of Interfering Signal
All bands	- 48 dBm	±10 MHz	CW signal
	- 48 dBm	±20 MHz	WCDMA signal *
Note*: The characteristics of the W-CDMA interference signal are specified in Annex C.			

Table 7.6A: Narrowband intermodulation performance requirement (Wide Area BS)

Operating band	Interfering Signal mean power	Offset	Type of Interfering Signal
II, III, IV, V, VIII, X, XII, XIII, XIV	- 47 dBm	±3.5 MHz	CW signal
	- 47 dBm	±5.9 MHz	GMSK modulated*
Note *: GMSK as defined in TS45.004.			

The static reference performance as specified in clause 7.2.1 shall be met for a Medium Range BS when the following signals are coupled to BS antenna input:

- A wanted signal at the assigned channel frequency with a mean power of -105 dBm.
- Two interfering signals with the following parameters.

Table 7.6B: Intermodulation performance requirement (Medium Range BS)

Operating band	Interfering Signal mean power	Offset	Type of Interfering Signal
All bands	- 44 dBm	±10 MHz	CW signal
	- 44 dBm	±20 MHz	WCDMA signal *
Note*: The characteristics of the W-CDMA interference signal are specified in Annex C.			

Table 7.6C: Narrowband intermodulation performance requirement (Medium Range BS)

Operating band	Interfering Signal mean power	Offset	Type of Interfering Signal
II, III, IV, V, VIII, X, XII, XIII, XIV	- 43 dBm	±3.5 MHz	CW signal
	- 43 dBm	±5.9 MHz	GMSK modulated*
Note*: GMSK as defined in TS45.004			

The static reference performance as specified in clause 7.2.1 shall be met for a Local Area /Home BS when the following signals are coupled to BS antenna input:

- A wanted signal at the assigned channel frequency with a mean power of -101 dBm.
- Two interfering signals with the following parameters.

Table 7.6D: Intermodulation performance requirement (Local Area / Home BS)

Operating band	Interfering Signal mean power	Offset	Type of Interfering Signal
All bands	-38 dBm	±10 MHz	CW signal
	-38 dBm	±20 MHz	WCDMA signal *
Note*: The characteristics of the W-CDMA interference signal are specified in Annex C.			

Table 7.6E: Narrowband intermodulation performance requirement (Local Area / Home BS)

Operating band	Interfering Signal mean power	Offset	Type of Interfering Signal
II, III, IV, V, VIII, X, XII, XIII, XIV	-37 dBm	±3.5 MHz	CW signal
	-37 dBm	±5.9 MHz	GMSK modulated*
Note *: GMSK as defined in TS45.004.			

7.7 Spurious emissions

The spurious emissions power is the power of emissions generated or amplified in a receiver that appear at the BS receiver antenna connector. The requirements apply to all BS with separate RX and TX antenna port. The test shall be performed when both TX and RX are on with the TX port terminated.

For all BS with common RX and TX antenna port the transmitter spurious emission as specified in section 6.6.3 is valid.

7.7.1 Minimum requirement

The power of any spurious emission shall not exceed:

Table 7.7: General spurious emission minimum requirement

Band	Maximum level	Measurement Bandwidth	Note
30MHz - 1 GHz	-57 dBm	100 kHz	With the exception of frequencies between 12.5 MHz below the first carrier frequency and 12.5 MHz above the last carrier frequency used by the BS.
1 GHz - 12.75 GHz	-47 dBm	1 MHz	With the exception of frequencies between 12.5 MHz below the first carrier frequency and 12.5 MHz above the last carrier frequency used by the BS.

Table 7.7A: Additional spurious emission requirements

Operating Band	Band	Maximum level	Measurement Bandwidth	Note
I	1920 - 1980 MHz	-78 dBm	3.84 MHz	
II	1850 - 1910 MHz	-78 dBm	3.84 MHz	
III	1710 - 1785 MHz	-78 dBm	3.84 MHz	
IV	1710 - 1755 MHz	-78 dBm	3.84 MHz	
V	824 - 849 MHz	-78 dBm	3.84 MHz	
VI, XIX	815 - 850 MHz	-78 dBm	3.84 MHz	
VII	2500 - 2570 MHz	-78 dBm	3.84 MHz	
VIII	880 - 915 MHz	-78 dBm	3.84 MHz	
IX	1749.9 - 1784.9 MHz	-78 dBm	3.84 MHz	
X	1710 - 1770 MHz	-78 dBm	3.84 MHz	
XI	1427.9 - 1447.9 MHz	-78 dBm	3.84 MHz	
XII	698 - 716 MHz	-78 dBm	3.84 MHz	
XIII	777 - 787 MHz	-78 dBm	3.84 MHz	
XIV	788 - 798 MHz	-78 dBm	3.84 MHz	
XXI	1447.9 - 1462.9 MHz	-78 dBm	3.84 MHz	

In addition, the requirement in Table 7.8 may be applied to geographic areas in which both UTRA-TDD and UTRA-FDD are deployed.

Table 7.8: Additional spurious emission requirements for the TDD bands

Operating Band	Protected Band	Maximum level	Measurement Bandwidth	Note
I	1900 - 1920 MHz	-78 dBm	3.84 MHz	Not applicable in Japan
	2010 - 2025 MHz	-52 dBm	1MHz	Applicable in Japan
	1880 - 1920 MHz	-84 dBm	1 MHz	Applicable in China
	2300 - 2400 MHz	-84 dBm	1 MHz	
VI, IX, XI, XIX, XXI	2010 - 2025 MHz	-52 dBm	1MHz	
VII	2570 - 2620 MHz	-84 dBm	1 MHz	
	2300 - 2400 MHz	-84 dBm	1 MHz	

In addition to the requirements in tables 7.7, 7.7A and 7.8, the co-existence requirements for co-located base stations specified in subclause 6.6.3.4 and 6.6.3.7.2 may also be applied.

8 Performance requirement

8.1 General

Performance requirements for the BS are specified for the measurement channels defined in Annex A and the propagation conditions in Annex B. The requirements only apply to those measurement channels that are supported by the base station. For FRC8 in Annex 9 and Annex 17 the Non E-DPCCH boosting and E-DPCCH boosting requirement only apply for the option supported by the base station. The performance requirements for the high speed train conditions which scenarios defined in Annex B.4A are optional.

Unless stated otherwise, performance requirements apply for a single cell only. Performance requirements for a BS supporting DC-HSUPA are defined in terms of single carrier requirements.

For BS with dual receiver antenna diversity, only the BS performance requirements with Rx diversity apply, the required E_b/N_0 shall be applied separately at each antenna port.

For BS without receiver antenna diversity, only the BS performance requirements without Rx diversity apply, the required E_b/N_0 shall be applied at the BS Rx antenna port.

The E_b/N_0 used in this section is defined as:

$$E_b / N_o = \frac{E_c}{N_o} \cdot \frac{L_{chip}}{L_{inf}}$$

Where:

E_c is the received total energy of DPDCH, DPCCH, HS-DPCCH, E-DPDCH and E-DPCCH per PN chip per antenna from all paths.

N_o is the total one-sided noise power spectral density due to all noise sources

L_{chip} is the number of chips per frame

L_{inf} is the number of information bits in DTCH excluding CRC bits per frame

Table 8.1: Summary of Base Station performance targets

Physical channel	Measurement channel	Static	Multi-path Case 1	Multi-path Case 2*	Multi-path Case 3*	Moving *	Birth / Death*
		Performance metric					
DCH	12.2 kbps	BLER<10 ⁻²	BLER<10 ⁻²	BLER<10 ⁻²	BLER<10 ⁻²	BLER<	BLER<
	64 kbps	BLER< 10 ⁻¹ ,10 ⁻²	BLER< 10 ⁻¹ , 10 ⁻²	BLER< 10 ⁻¹ ,10 ⁻²	BLER< 10 ⁻¹ , 10 ⁻² ,10 ⁻³	BLER<	BLER<
	144 kbps	BLER< 10 ⁻¹ ,10 ⁻²	BLER< 10 ⁻¹ ,10 ⁻²	BLER< 10 ⁻¹ ,10 ⁻²	BLER< 10 ⁻¹ , 10 ⁻² ,10 ⁻³	-	-
	384 kbps	BLER< 10 ⁻¹ ,10 ⁻²	BLER< 10 ⁻¹ ,10 ⁻²	BLER< 10 ⁻¹ ,10 ⁻²	BLER< 10 ⁻¹ , 10 ⁻² ,10 ⁻³	-	-
* Not applicable for Home BS							

8.2 Demodulation in static propagation conditions

8.2.1 Demodulation of DCH

The performance requirement of DCH in static propagation conditions is determined by the maximum Block Error Ratio (BLER) allowed when the receiver input signal is at a specified E_b/N_0 limit. The BLER is calculated for each of the measurement channels supported by the base station.

8.2.1.1 Minimum requirement

The BLER shall not exceed the limit for the E_b/N_0 specified in Table 8.2.

Table 8.2: Performance requirements in AWGN channel

Measurement channel	Received E_b/N_0 For BS with Rx diversity	Received E_b/N_0 For BS without Rx diversity	Required BLER
12.2 kbps	n.a.	n.a.	$< 10^{-1}$
	5.1 dB	8.3 dB	$< 10^{-2}$
64 kbps	1.5 dB	4.7 dB	$< 10^{-1}$
	1.7 dB	4.8 dB	$< 10^{-2}$
144 kbps	0.8 dB	3.8 dB	$< 10^{-1}$
	0.9 dB	4 dB	$< 10^{-2}$
384 kbps	0.9 dB	4 dB	$< 10^{-1}$
	1.0 dB	4.1 dB	$< 10^{-2}$

8.3 Demodulation of DCH in multipath fading conditions

8.3.1 Multipath fading Case 1

The performance requirement of DCH in multipath fading Case 1 is determined by the maximum Block Error Ratio (BLER) allowed when the receiver input signal is at a specified E_b/N_0 limit. The BLER is calculated for each of the measurement channels supported by the base station.

8.3.1.1 Minimum requirement

The BLER shall not exceed the limit for the E_b/N_0 specified in Table 8.3.

Table 8.3: Performance requirements in multipath Case 1 channel

Measurement channel	Received E_b/N_0 For BS with Rx diversity	Received E_b/N_0 For BS without Rx diversity	Required BLER
12.2 kbps	n.a.	n.a.	$< 10^{-1}$
	11.9 dB	19.1 dB	$< 10^{-2}$
64 kbps	6.2 dB	11.6 dB	$< 10^{-1}$
	9.2 dB	15.9 dB	$< 10^{-2}$
144 kbps	5.4 dB	10.8 dB	$< 10^{-1}$
	8.4 dB	15 dB	$< 10^{-2}$
384 kbps	5.8 dB	11.2 dB	$< 10^{-1}$
	8.8 dB	15.5 dB	$< 10^{-2}$

8.3.2 Multipath fading Case 2

The performance requirement of DCH in multipath fading Case 2 is determined by the maximum Block Error Ratio (BLER) allowed when the receiver input signal is at a specified E_b/N_0 limit. The BLER is calculated for each of the measurement channels supported by the base station.

This requirement shall not be applied to Home BS.

8.3.2.1 Minimum requirement

The BLER shall not exceed the limit for the E_b/N_0 specified in Table 8.4.

Table 8.4: Performance requirements in multipath Case 2 channel

Measurement channel	Received E_b/N_0 For BS with Rx Diversity	Received E_b/N_0 For BS without Rx Diversity	Required BLER
12.2 kbps	n.a.	n.a.	$< 10^{-1}$
	9.0 dB	15 dB	$< 10^{-2}$
64 kbps	4.3 dB	9.2 dB	$< 10^{-1}$
	6.4 dB	12.3 dB	$< 10^{-2}$
144 kbps	3.7 dB	8.2 dB	$< 10^{-1}$
	5.6 dB	11.5 dB	$< 10^{-2}$
384 kbps	4.1 dB	8.7 dB	$< 10^{-1}$
	6.1 dB	12.1 dB	$< 10^{-2}$

8.3.3 Multipath fading Case 3

The performance requirement of DCH in multipath fading Case 3 is determined by the maximum Block Error Ratio (BLER) allowed when the receiver input signal is at a specified E_b/N_0 limit. The BLER is calculated for each of the measurement channels supported by the base station.

This requirement shall not be applied to Home BS.

8.3.3.1 Minimum requirement

The BLER shall not exceed the limit for the E_b/N_0 specified in Table 8.5.

Table 8.5: Performance requirements in multipath Case 3 channel

Measurement channel	Received E_b/N_0 For BS with Rx Diversity	Received E_b/N_0 For BS without Rx Diversity	Required BLER
12.2 kbps	n.a.	n.a.	$< 10^{-1}$
	7.2 dB	10.8 dB	$< 10^{-2}$
	8.0 dB	11.7 dB	$< 10^{-3}$
64 kbps	3.4 dB	7.1 dB	$< 10^{-1}$
	3.8 dB	7.7 dB	$< 10^{-2}$
	4.1 dB	8.5 dB	$< 10^{-3}$
144 kbps	2.8 dB	6 dB	$< 10^{-1}$
	3.2 dB	6.7 dB	$< 10^{-2}$
	3.6 dB	7.2 dB	$< 10^{-3}$
384 kbps	3.2 dB	6.5 dB	$< 10^{-1}$
	3.6 dB	7.2 dB	$< 10^{-2}$
	4.2 dB	7.9 dB	$< 10^{-3}$

8.3.4 Multipath fading Case 4

The performance requirement of DCH in multipath fading Case 4 in case of a Wide Area BS is determined by the maximum Block Error Ratio (BLER) allowed when the receiver input signal is at a specified E_b/N_0 limit. The BLER is calculated for each of the measurement channels supported by the base station.

8.3.4.1 Minimum requirement

The BLER shall not exceed the limit for the E_b/N_0 specified in Table 8.5A.

Table 8.5A: Performance requirements in multipath Case 4 channel

Measurement channel	Received E_b/N_0 For BS with Rx Diversity	Received E_b/N_0 For BS without Rx Diversity	Required BLER
12.2 kbps	n.a.	n.a.	$< 10^{-1}$
	10.2 dB	13.8 dB	$< 10^{-2}$
	11.0 dB	14.7 dB	$< 10^{-3}$
64 kbps	6.4 dB	10.1 dB	$< 10^{-1}$
	6.8 dB	10.7 dB	$< 10^{-2}$
	7.1 dB	11.5 dB	$< 10^{-3}$
144 kbps	5.8 dB	9 dB	$< 10^{-1}$
	6.2 dB	9.7 dB	$< 10^{-2}$
	6.6 dB	10.2 dB	$< 10^{-3}$
384 kbps	6.2 dB	9.5 dB	$< 10^{-1}$
	6.6 dB	10.2 dB	$< 10^{-2}$
	7.2 dB	10.9 dB	$< 10^{-3}$

8.4 Demodulation of DCH in moving propagation conditions

The performance requirement of DCH in moving propagation conditions is determined by the maximum Block Error Ratio (BLER) allowed when the receiver input signal is at a specified E_b/N_0 limit. The BLER is calculated for each of the measurement channels supported by the base station.

This requirement shall not be applied to Home BS.

8.4.1 Minimum requirement

The BLER shall not exceed the limit for the E_b/N_0 specified in Table 8.6.

Table 8.6: Performance requirements in moving channel

Measurement channel	Received E_b/N_0 For BS with Rx Diversity	Received E_b/N_0 For BS without Rx Diversity	Required BLER
12.2 kbps	n.a.	n.a.	$< 10^{-1}$
	5.7 dB	8.7 dB	$< 10^{-2}$
64 kbps	2.1 dB	5.3 dB	$< 10^{-1}$
	2.2 dB	5.5 dB	$< 10^{-2}$

8.5 Demodulation of DCH in birth/death propagation conditions

The performance requirement of DCH in birth/death propagation conditions is determined by the maximum Block Error Ratio (BLER) allowed when the receiver input signal is at a specified E_b/N_0 limit. The BLER is calculated for each of the measurement channels supported by the base station.

This requirement shall not be applied to Home BS.

8.5.1 Minimum requirement

The BLER shall not exceed the limit for the E_b/N_0 specified in Table 8.7.

Table 8.7: Performance requirements in birth/death channel

Measurement channel	Received E_b/N_0 For BS with Rx Diversity	Received E_b/N_0 For BS without Rx Diversity	Required BLER
12.2 kbps	n.a.	n.a.	$< 10^{-1}$
	7.7 dB	10.8 dB	$< 10^{-2}$
64 kbps	4.1 dB	7.4 dB	$< 10^{-1}$
	4.2 dB	7.5 dB	$< 10^{-2}$

8.5A Demodulation of DCH in high speed train conditions

8.5A.1 General

The performance requirement of DCH in high speed train conditions is determined by the maximum BLER allowed when the receiver input signal is at a specified E_b/N_0 limit. The BLER is calculated for the measurement channel supported by the base station.

This requirement shall not be applied to Home BS.

8.5A.2 Minimum requirement

The BLER shall not exceed the limit for the E_b/N_0 specified in Table 8.7A.

Table 8.7A: Performance requirements in high speed train conditions

Scenario	Measurement channel	Received E_b/N_0 For BS with Rx Diversity	Received E_b/N_0 For BS without Rx Diversity	Required BLER
1	12.2 kbps	6.5 dB	9.6 dB	$< 10^{-2}$
2	12.2 kbps	n.a.	8.8 dB	$< 10^{-2}$
3	12.2 kbps	n.a.	10.1 dB	$< 10^{-2}$

8.6 (void)

8.7 Performance requirement for RACH

Performance requirement for RACH consists of two parts: preamble detection and message demodulation. Requirements for these are in sections 8.7.1 and 8.7.2, respectively. Requirements are defined for three propagation conditions: static, fading case 3, and high speed train conditions. The propagation conditions are defined in annexes B.1, B.2, and B.4A.

8.7.1 Performance requirement for RACH preamble detection

Probability of false alarm, P_{fa} (=false detection of the preamble) when the preamble was not sent, shall be 10^{-3} or less. The performance measure Required E_c/N_0 at probability of detection, P_d of 0.99 and 0.999. Only 1 signature is used and it is known by the receiver. The requirement for preamble detection, when the preamble was sent is in table 8.9, 8.10, and 8.10A for static, case 3 fading, and high speed train conditions.

The requirements in Table 8.10 and Table 8.10A shall not be applied to Home BS.

Table 8.9: Requirements for E_c/N_0 of P_d in static propagation condition

	E_c/N_0 for required $P_d \geq 0.99$	E_c/N_0 for required $P_d \geq 0.999$
BS with Rx Diversity	-20.5 dB	-20.1 dB
BS without Rx Diversity	-17.6 dB	-16.8 dB

Table 8.10: Requirements of E_c/N_0 of P_d in case 3 fading

	E_c/N_0 for required $P_d \geq 0.99$	E_c/N_0 for required $P_d \geq 0.999$
BS with Rx Diversity	-15.5 dB	-13.4 dB
BS without Rx Diversity	-9.4 dB	-6.4 dB

Table 8.10A: Requirements of E_c/N_0 of Pd in high speed train conditions

Scenario		E_c/N_0 for required Pd ≥ 0.99	E_c/N_0 for required Pd ≥ 0.999
1	BS with Rx Diversity	-18.1 dB	-17.9 dB
	BS without Rx Diversity	-15.2 dB	-14.8 dB
2	BS with Rx Diversity	n.a.	n.a.
	BS without Rx Diversity	-15.6 dB	-14.8 dB
3	BS with Rx Diversity	n.a.	n.a.
	BS without Rx Diversity	-15.3 dB	-15.1 dB

8.7.2 Demodulation of RACH message

The performance measure is required E_b/N_0 for block error rate (BLER) of 10^{-1} and 10^{-2} . Both measurement channels have TTI=20 ms. Payloads are 168 and 360 bits. Channel coding is rate $\frac{1}{2}$ convolutional coding.

The requirements in Table 8.12 and Table 8.12A shall not be applied to Home BS.

8.7.2.1 Minimum requirements for Static Propagation Condition

Table 8.11: Required E_b/N_0 for static propagation

Transport Block size TB and TTI in frames	168 bits, TTI = 20 ms		360 bits, TTI = 20 ms	
	E_b/N_0 for required BLER $< 10^{-1}$	E_b/N_0 for required BLER $< 10^{-2}$	E_b/N_0 for required BLER $< 10^{-1}$	E_b/N_0 for required BLER $< 10^{-2}$
BS with Rx Diversity	4.1 dB	5.0 dB	3.9 dB	4.8 dB
BS without Rx Diversity	7.2 dB	8.1 dB	6.9 dB	7.8 dB

8.7.2.2 Minimum requirements for Multipath Fading Case 3

Table 8.12: Required E_b/N_0 for case 3 fading

Transport Block size TB and TTI in frames	168 bits, TTI = 20 ms		360 bits, TTI = 20 ms	
	E_b/N_0 for required BLER $< 10^{-1}$	E_b/N_0 for required BLER $< 10^{-2}$	E_b/N_0 for required BLER $< 10^{-1}$	E_b/N_0 for required BLER $< 10^{-2}$
BS with Rx Diversity	7.4 dB	8.5 dB	7.3 dB	8.3 dB
BS without Rx Diversity	11.1 dB	12.4 dB	11.0 dB	12.1 dB

8.7.2.3 Minimum requirements for high speed train conditions

Table 8.12A: Required E_b/N_0 for high speed train conditions

Transport Block size TB and TTI in frames		168 bits, TTI = 20 ms		360 bits, TTI = 20 ms	
Scenario		E_b/N_0 for required BLER < 10^{-1}	E_b/N_0 for required BLER < 10^{-2}	E_b/N_0 for required BLER < 10^{-1}	E_b/N_0 for required BLER < 10^{-2}
1	BS with Rx Diversity	5.1 dB	6.4 dB	5.3 dB	6.2 dB
	BS without Rx Diversity	8.1 dB	9.4 dB	8.3 dB	9.2 dB
2	BS with Rx Diversity	n.a.	n.a.	n.a.	n.a.
	BS without Rx Diversity	7.7 dB	8.6 dB	7.4 dB	8.3 dB
3	BS with Rx Diversity	n.a.	n.a.	n.a.	n.a.
	BS without Rx Diversity	8.2 dB	9.6 dB	8.4 dB	9.3 dB

8.8 (void)

Table 8.13: (void)

Table 8.14: (void)

8.9 (void)

Table 8.15: (void)

8.10 Performance of ACK/NACK detection for HS-DPCCH

Performance requirements of HS-DPCCH signaling detection consist of two parts; ACK false alarm and ACK mis-detection. Requirements for these are 8.10.1 and 8.10.2, respectively. Performance requirements are specified for the reference measurement channel of HS-DPCCH and four propagation conditions: static, multi-path fading case 1, case2 and case3. The reference measurement channel for HS-DPCCH is defined in Annex A.8. The propagation conditions are defined in Annex B.1 and B.2.

8.10.1 ACK false alarm

The probability of ACK false alarm, $P(\text{DTX} \rightarrow \text{ACK})$ (= false ACK detection when DTX is transmitted) shall not exceed the required error ratio for the E_c/N_0 specified in Table 8.16.

Table 8.16: Performance requirements for ACK false alarm

Propagation condition	Received E_c/N_0 (Test condition) For BS with Rx Diversity	Required error ratio
Static	-19.9 dB	$< 10^{-2}$
Case 1	-13.1 dB	$< 10^{-2}$
Case 2*	-16.0 dB	$< 10^{-2}$
Case 3*	-17.8 dB	$< 10^{-2}$
* Not applicable for Home BS		

8.10.2 ACK mis-detection

The probability of ACK mis-detection, $P(\text{ACK} \rightarrow \text{NACK or DTX})$ (= mis-detected when ACK is transmitted) shall not exceed the required error ratio for the E_c/N_0 specified in Table 8.17.

Table 8.17: Performance requirements for ACK mis-detection

Propagation condition	Received E_c/N_0 For BS with Rx Diversity	Required error ratio
Static	-17.3 dB	$< 10^{-2}$
Case 1	-10.7 dB	$< 10^{-2}$
Case 2*	-13.6 dB	$< 10^{-2}$
Case 3*	-12.1 dB	$< 10^{-2}$
* Not applicable for Home BS		

8.11 Demodulation of E-DPDCH in multipath fading condition

The performance requirement of the E-DPDCH in multi path fading condition is determined by the minimum throughput, R. For the test parameters specified in Table 8.18, the minimum requirements are specified in Table 8.19. For a BS supporting DC-HSUPA the requirements for FRC1, FRC2, FRC3 and FRC8 shall apply on each cell.

Table 8.18: Test parameters for testing E-DPDCH

Parameter	Unit	Test	
RSN		{0, 1, 2, 3}	
HARQ combining		IR	
Maximum number of HARQ transmission		4	
Power control		OFF	
DPCCH slot format		FRC8 or BS supporting DC-HSUPA	1
		otherwise	0
E-DPCCH # code words		1024, no optimization based on prior knowledge of valid code words.	
Physical channels to be turned on		DPCCH, E-DPDCH and E-DPCCH	

Table 8.19 Minimum Requirement for E-DPDCH

Fixed Reference Channel		Reference value, E_c/N_0 (dB), for $R \geq 30\%$ and $R \geq 70\%$ of maximum information bit rate								
		FRC1	FRC2	FRC3	FRC4	FRC5	FRC6	FRC7	FRC8	
Non E-DPCCH boosting	E-DPCCH Boosting									
Pedestrian A without RX diversity	30%	-2.4	0.8	2.4	-7.1	-4.4	-1.4	-15.0	NA	NA
	70%	3.7	7.1	9.1	-0.6	2.1	5.2	-8.4	16.2	16.9
Pedestrian A with RX diversity	30%	-6.2	-3.1	-1.4	-10.6	-8.0	-5.0	-18.3	NA	NA
	70%	-1.0	2.2	4.1	-5.2	-2.6	0.2	-13.3	10.1	10.4
Pedestrian B without RX diversity*	30%	-2.5	1.1	3.5	-7.5	-4.7	-1.3	-13.6	NA	NA
	70%	3.9	NA	NA	-2.1	0.9	5.3	-10.1	NA	NA
Pedestrian B with RX diversity*	30%	-6.1	-3.1	-1.0	-10.7	-8.1	-4.9	-18.0	NA	NA
	70%	-0.3	3.9	8.2	-5.7	-2.9	0.7	-13.8	12.4	13.1
Vehicular 30 without RX diversity*	30%	-2.5	1.0	3.2	-7.5	-4.6	-1.4	-14.3	NA	NA
	70%	4.9	NA	NA	-1.7	1.4	5.8	-10.1	NA	NA
Vehicular 30 with RX diversity*	30%	-6.1	-2.9	-0.9	-10.7	-8.0	-4.9	-17.6	NA	NA
	70%	0.6	4.7	8.8	-5.4	-2.6	1.0	-13.7	13.3	13.6
Vehicular 120 without RX diversity*	30%	-2.1	1.3	3.6	-7.3	-4.2	-1.2	-14.0	NA	NA
	70%	5.1	NA	NA	-1.3	1.5	6.1	-10.1	NA	NA
Vehicular 120 with RX diversity*	30%	-5.7	-2.6	-0.5	-10.4	-7.6	-4.3	-17.0	NA	NA
	70%	0.7	5.0	9.5	-5.1	-2.3	1.2	-13.2	NA	NA

* Not applicable for Home BS

8.12 Performance of signaling detection for E-DPCCH in multipath fading condition

The performance requirement of the E-DPCCH in multi path fading condition is determined by the false alarm rate and the missed detection rate. For the test parameters specified in Table 8.20, the minimum requirements are specified in Table 8.21 and 8.22.

Table 8.20: Test parameters for testing E-DPCCH

Parameter	Unit	Test
Power control		Off
E-DPCCH # code words		1024, no optimization based on prior knowledge of valid code words.
Physical channels to be turned on for missed detection test		DPCCH, E-DPDCH and E-DPCCH
Physical channels to be turned on for false alarm test		DPCCH

Table 8.21: Performance requirements for E-DPCCH false alarm

Propagation conditions	Received E_c/N_0		Required detection probability
	FRC1	FRC4	
Pedestrian A without RX diversity	-1.6 dB	-5.0 dB	$< 10^{-2}$
Pedestrian A with RX diversity	-11.2 dB	-12.3 dB	$< 10^{-2}$
Pedestrian B without RX diversity*	-13.8 dB	-15.2 dB	$< 10^{-2}$
Pedestrian B with RX diversity*	-16.4 dB	-17.6 dB	$< 10^{-2}$
Vehicular 30 without RX diversity*	-12.1 dB	-16.7 dB	$< 10^{-2}$
Vehicular 30 with RX diversity*	-15.7 dB	-18.6 dB	$< 10^{-2}$
Vehicular 120 without RX diversity*	-13.8 dB	-18.3 dB	$< 10^{-2}$
Vehicular 120 with RX diversity*	-17.1 dB	-19.6 dB	$< 10^{-2}$
* Not applicable for Home BS			

Table 8.22: Performance requirements for E-DPCCH missed detection

Propagation conditions	Received E_c/N_0		Required missed detection probability
	FRC1	FRC4	
Pedestrian A without RX diversity	13.7 dB	7.4 dB	$< 2 \cdot 10^{-3}$
Pedestrian A with RX diversity	1.2 dB	-2.8 dB	$< 2 \cdot 10^{-3}$
Pedestrian B without RX diversity*	1.5 dB	-2.8 dB	$< 2 \cdot 10^{-3}$
Pedestrian B with RX diversity*	-4.0 dB	-8.1 dB	$< 2 \cdot 10^{-3}$
Vehicular 30 without RX diversity*	3.2 dB	-4.3 dB	$< 2 \cdot 10^{-3}$
Vehicular 30 with RX diversity*	-3.3 dB	-9.1 dB	$< 2 \cdot 10^{-3}$
Vehicular 120 without RX diversity*	1.5 dB	-5.9 dB	$< 2 \cdot 10^{-3}$
Vehicular 120 with RX diversity*	-4.7 dB	-10.1 dB	$< 2 \cdot 10^{-3}$
* Not applicable for Home BS			

Annex A (normative): Measurement channels

A.1 Summary of UL reference measurement channels

The parameters for the UL reference measurement channels are specified in Table A.1 and the channel coding is detailed in figure A.2 through A.6 respectively. Note that for all cases, one DPCCH shall be attached to DPDCH(s).

Table A.1: Reference measurement channels for UL DCH

Parameter		DCH for DTCH / DCH for DCCH				Unit
DPDCH	Information bit rate	12.2/2.4	64/2.4	144/2.4	384/2.4	kbps
	Physical channel	60/15	240/15	480/15	960/15	kbps
	Spreading factor	64	16	8	4	
	Repetition rate	22/22	19/19	8/9	-18/-17	%
	Interleaving	20	40	40	40	ms
	Number of DPDCHs	1	1	1	1	
DPCCH	Dedicated pilot	6				bit/slot
	Power control	2				bit/slot
	TFCI	2				bit/slot
	Spreading factor	256				
Power ratio of DPCCH/DPDCH		-2.69	-5.46	-9.54	-9.54	dB
Amplitude ratio of DPCCH/DPDCH		0.7333	0.5333	0.3333	0.3333	

A.2 UL reference measurement channel for 12.2 kbps

The parameters for the UL reference measurement channel for 12.2 kbps are specified in Table A.2 and the channel coding is detailed in Figure A.2.

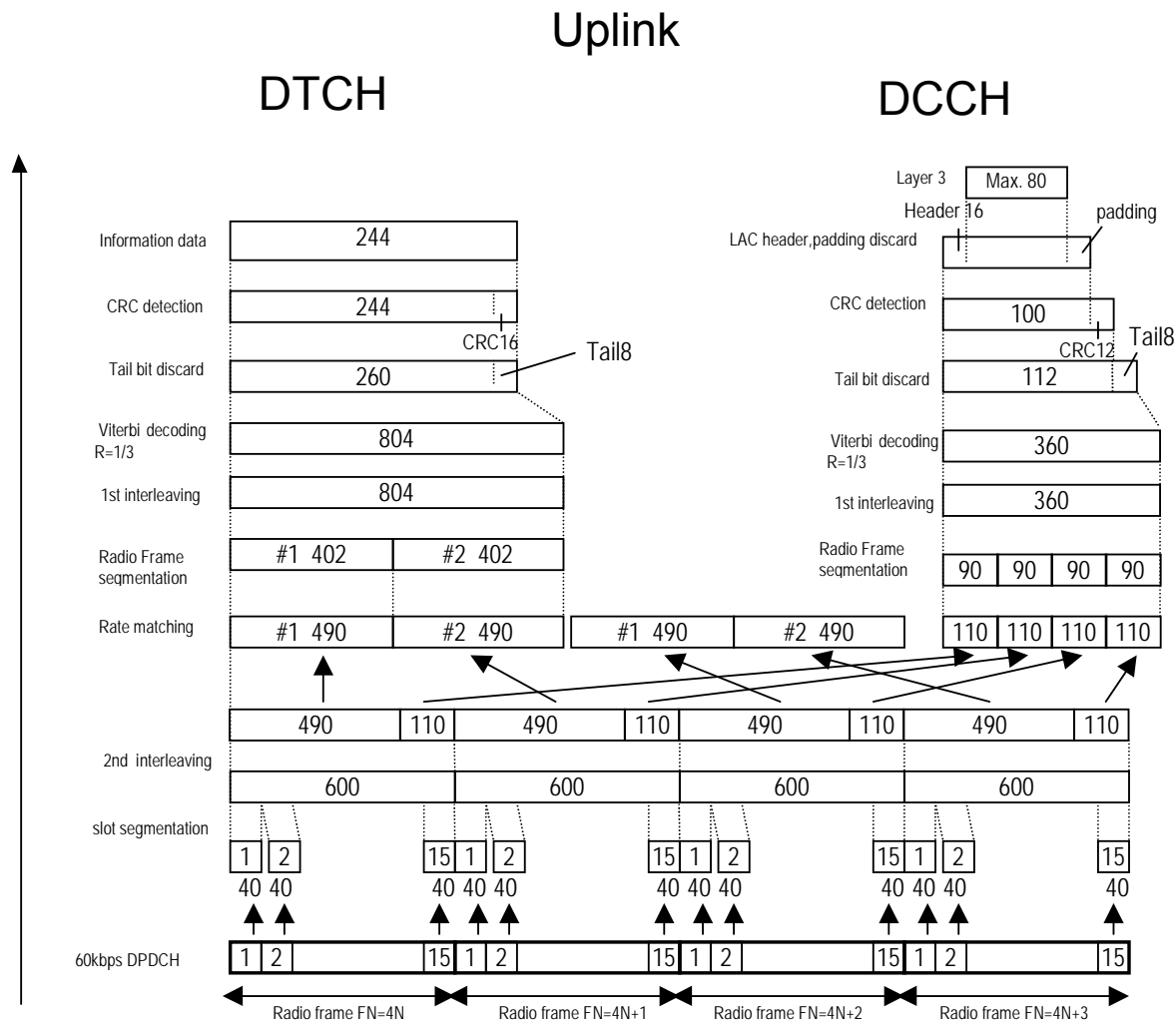

Figure A.2: Channel coding for the UL reference measurement channel (12.2 kbps)

Table A.2: UL reference measurement channel (12.2 kbps)

Parameter	Level	Unit
Information bit rate	12.2	kbps
DPCH	60	kbps
Power control	Off	
TFCI	On	
Repetition	22	%

A.3 UL reference measurement channel for 64 kbps

The parameters for the UL reference measurement channel for 64 kbps are specified in Table A.3 and the channel coding is detailed in Figure A.3.

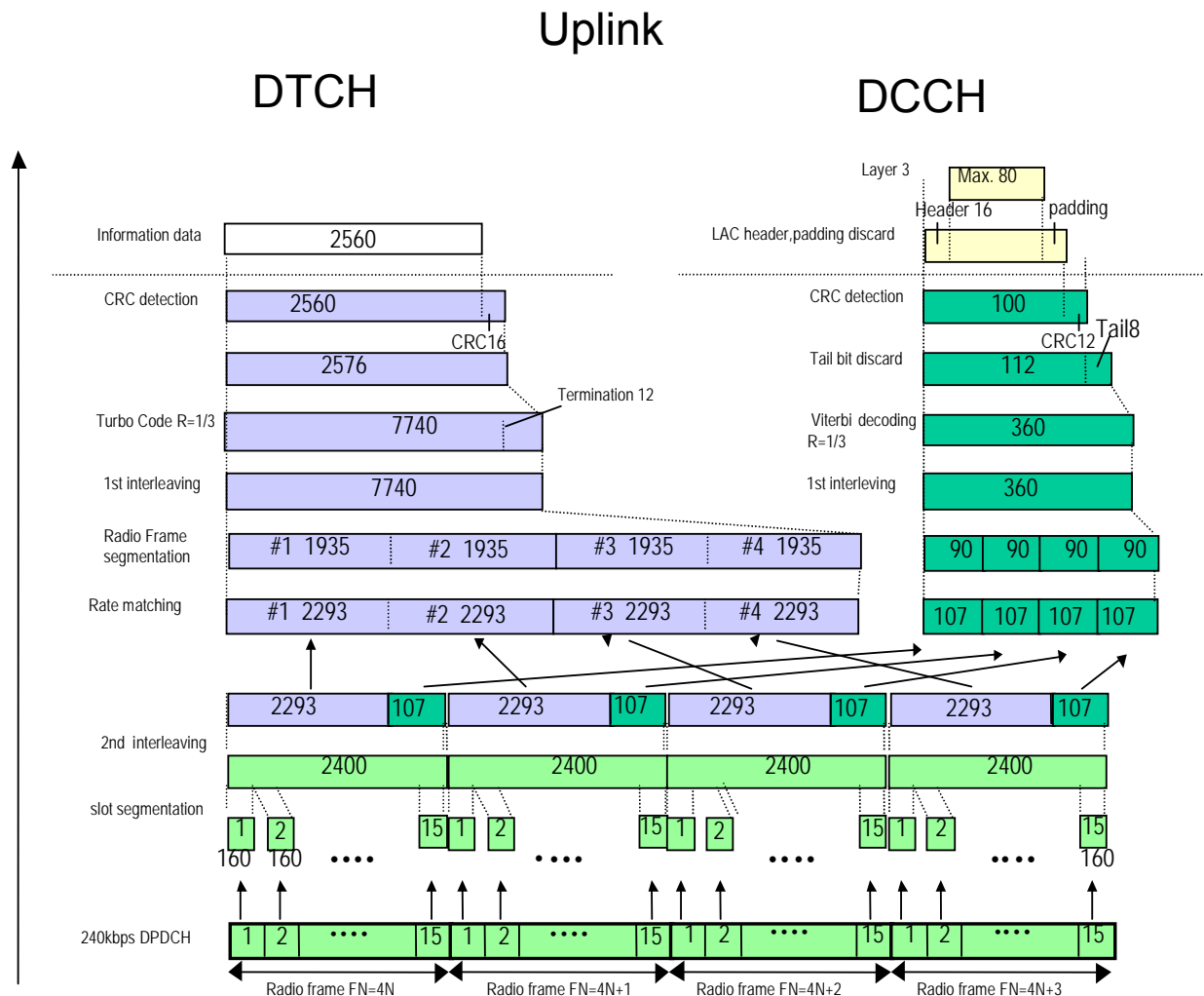

Figure A.3: Channel coding for the UL reference measurement channel (64 kbps)

Table A.3: UL reference measurement channel (64kbps)

Parameter	Level	Unit
Information bit rate	64	kbps
DPCH	240	kbps
Power control	Off	
TFCI	On	
Repetition	19	%

A.4 UL reference measurement channel for 144 kbps

The parameters for the UL reference measurement channel for 144 kbps are specified in Table A.4 and the channel coding is detailed in Figure A.4.

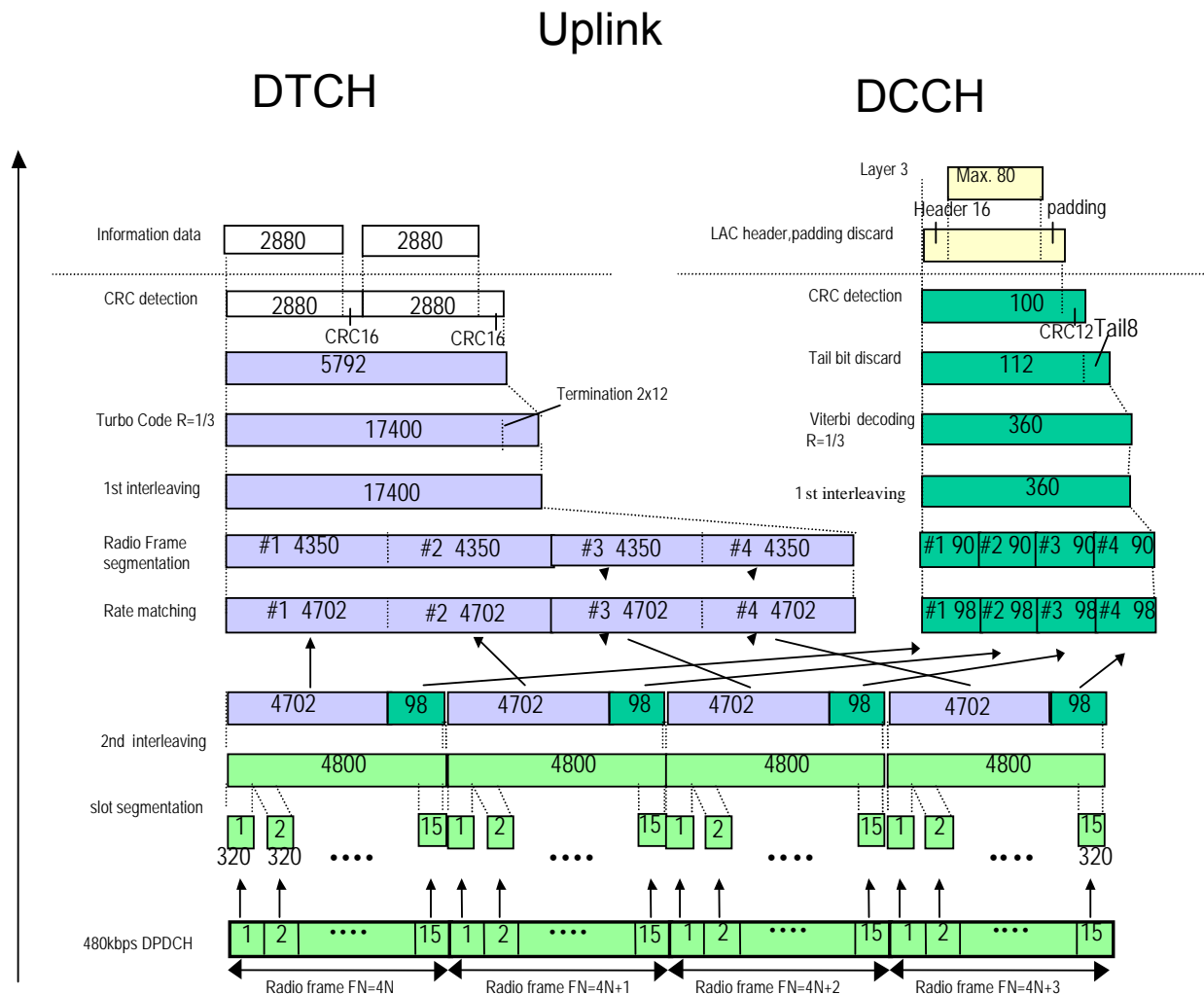

Figure A.4: Channel coding for the UL reference measurement channel (144 kbps)

Table A.4: UL reference measurement channel (144kbps)

Parameter	Level	Unit
Information bit rate	144	Kbps
DPCH	480	Kbps
Power control	Off	
TFCI	On	
Repetition	8	%

A.5 UL reference measurement channel for 384 kbps

The parameters for the UL reference measurement channel for 384 kbps are specified in Table A.5 and the channel coding is detailed in Figure A.5.

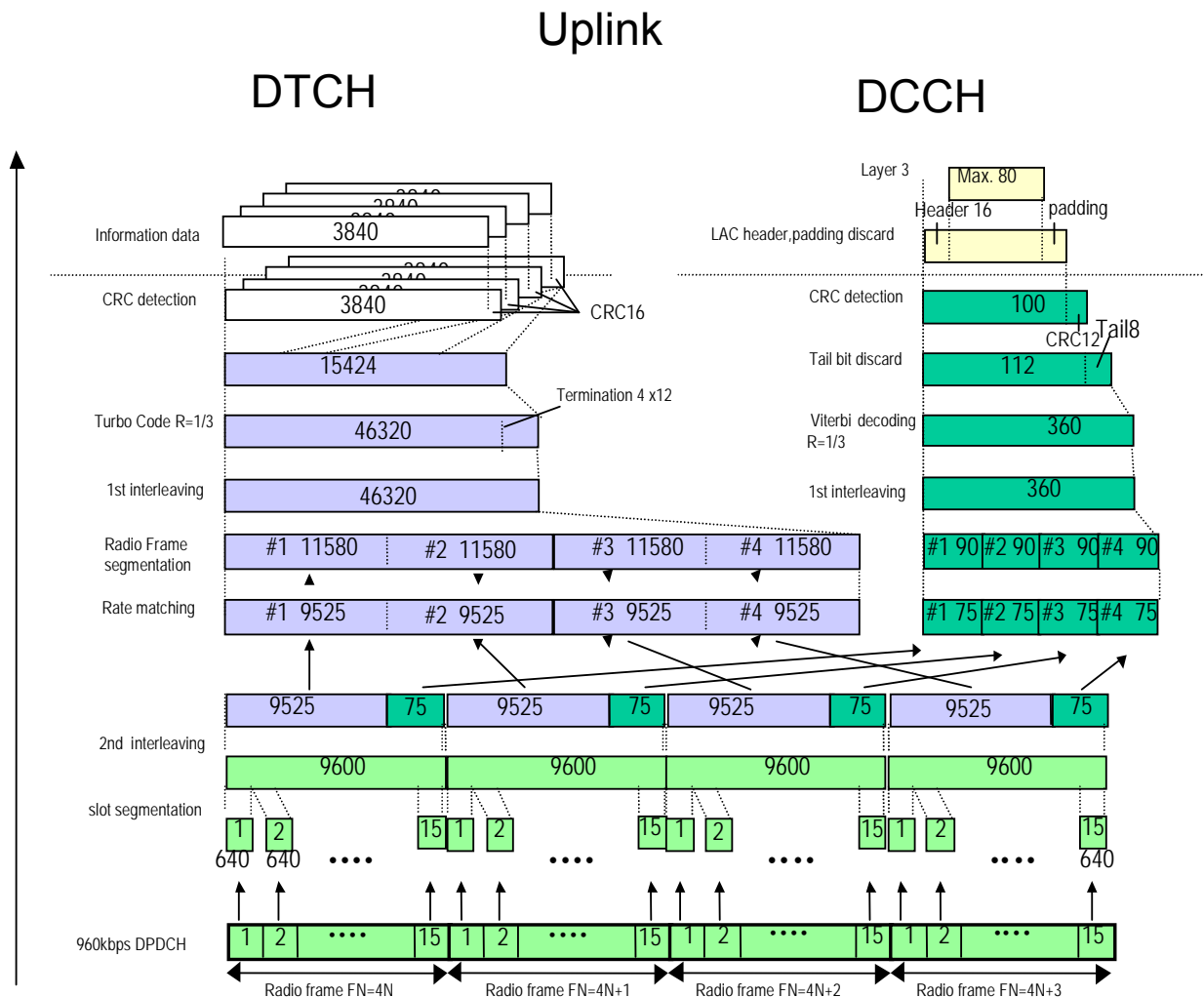

Figure A.5: Channel coding for the UL reference measurement channel (384 kbps)

Table A.5: UL reference measurement channel (384kbps)

Parameter	Level	Unit
Information bit rate	384	Kbps
DPCH	960	Kbps
Power control	Off	
TFCI	On	
Puncturing	18	%

A.6 (void)

Figure A.6: (void)

Table A.6: (void)

A.7 Reference measurement channels for UL RACH

The parameters for the UL RACH reference measurement channels are specified in Table A.7.

Table A.7: Reference measurement channels for UL RACH

Parameter		Unit	
RACH	CRC	16	bits
	Channel Coding	Rate ½ conv. coding	
	TTI	20	ms
	TB size	168, 360	bits
	Rate Matching	Repetition	
	Number of diversity antennas	2	
	Preamble detection window size	256	chips
	Ratio of preamble power and total message power	0	dB
Power ratio of RACH Control/Data TB = 168		-2.69	dB
Power ratio of Control/Data TB = 360		-3.52	dB

A.8 Reference measurement channel for HS-DPCCH

The parameters for the UL HS-DPCCH reference measurement channel are specified in Table A.8.

Table A.8: Reference measurement channel for HS-DPCCH

Parameter		Unit		
DPDCH	DTCH	Information bit rate	12.2	kbps
		Physical channel	60	kbps
		Repetition rate	22	%
	DCCH	Information bit rate	2.4	kbps
		Physical channel	15	kbps
		Repetition rate	22	%
	Spreading factor		64	
	Interleaving		20	ms
	Number of DPDCHs		1	
DPCCH	Dedicated pilot		6	bits/slot
	Power control		2	bits/slot
	TFCI		2	bits/slot
	Spreading factor		256	
Power ratio of DPCCH/DPDCH		-2.69	dB	
Amplitude ratio of DPCCH/DPDCH		0.7333		
Closed loop power control		OFF		
HS-DPCCH repetition		1		
HS-DPCCH power offset to DPCCH		0	dB	
HS-DPCCH timing offset to DPCCH		0	symbol	

DPDCH/DPCCH are same as 12.2kbps reference measurement channel specified in Annex A.2.

A.9 Summary of E-DPDCH Fixed reference channels

Table A.9

Fixed Ref Channel	TTI [ms]	N_{INF}	SF_1	SF_2	SF_3	SF_4	N_{BIN}	Coding rate	Max inf bit rate [kbps]
FRC1	2	2706	4	4	0	0	3840	0.705	1353.0
FRC2	2	5412	2	2	0	0	7680	0.705	2706.0
FRC3	2	8100	2	2	4	4	11520	0.703	4050.0
FRC4	10	5076	4	0	0	0	9600	0.529	507.6
FRC5	10	9780	4	4	0	0	19200	0.509	978.0
FRC6	10	19278	2	2	0	0	38400	0.502	1927.8
FRC7	10	690	16	0	0	0	2400	0.288	69.0
FRC8	2	16218	2	2	4	4	23040	0.704	8109.0

A.10 E-DPDCH Fixed reference channel 1 (FRC1)

Table A.10

Parameter	Unit	Value
Maximum. Inf. Bit Rate	kbps	1353.0
TTI	ms	2
Number of HARQ Processes	Processes	8
Information Bit Payload (N_{INF})	Bits	2706
Binary Channel Bits per TTI (N_{BIN}) (3840 / SF x TTI sum for all channels)	Bits	3840
Coding Rate (N_{INF} / N_{BIN})		0.705
Physical Channel Codes	SF for each physical channel	{4,4}
E-DPDCH testing: E-DPDCH/DPCCH power ratio E-DPCCH/DPCCH power ratio	dB dB dB dB	Diversity: 8.94 Non-diversity: 12.04 Diversity: 2.05 Non-diversity: 6.02 E-DPDCH /DPCCH power ratio is calculated for a single E-DPDCH.
E-DPCCH missed detection testing: E-DPDCH/DPCCH power ratio E-DPCCH/DPCCH power ratio	dB dB dB dB	Diversity: 8.94 Non-diversity: 12.04 Diversity: -1.94 Non-diversity: 0.00

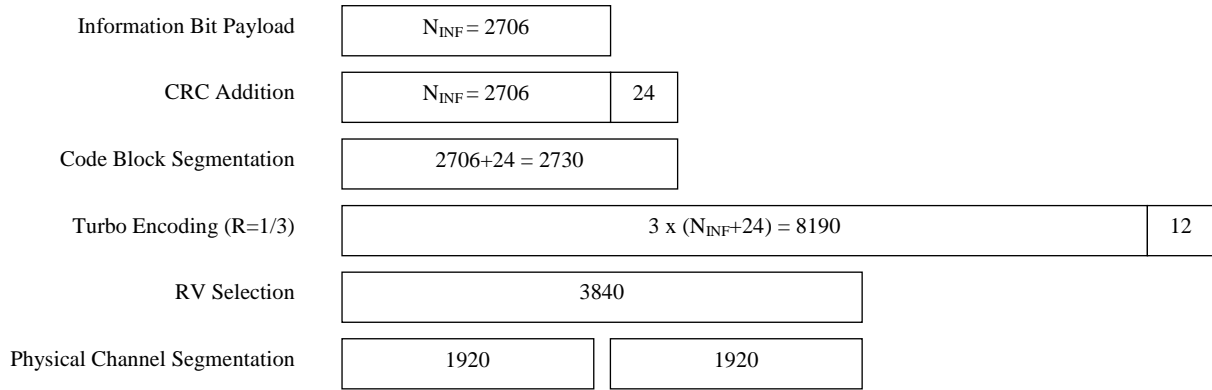

Figure A.10

A.11 E-DPDCH Fixed reference channel 2 (FRC2)

Table A.11

Parameter	Unit	Value
Maximum. Inf. Bit Rate	kbps	2706.0
TTI	ms	2
Number of HARQ Processes	Processes	8
Information Bit Payload (N_{INF})	Bits	5412
Binary Channel Bits per TTI (N_{BIN}) (3840 / SF x TTI sum for all channels)	Bits	7680
Coding Rate (N_{INF} / N_{BIN})		0.705
Physical Channel Codes	SF for each physical channel	{2,2}
E-DPDCH testing: E-DPDCH/DPCCH power ratio E-DPCCH/DPCCH power ratio	dB dB dB dB	Diversity: 9.92 Non-diversity: 13.00 Diversity: 4.08 Non-diversity: 6.02 E-DPDCH /DPCCH power ratio is calculated for a single E-DPDCH.

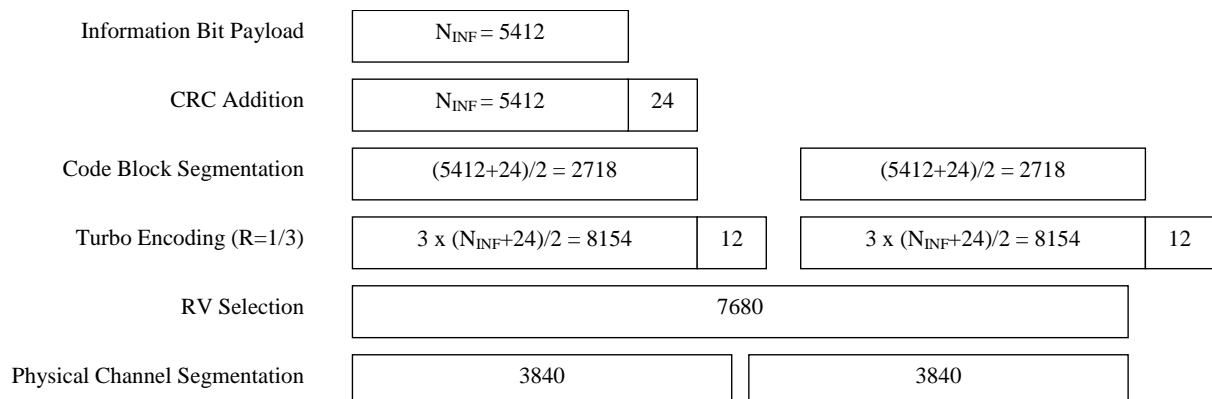

Figure A.11

A.12 E-DPDCH Fixed reference channel 3 (FRC3)

Table A.12

Parameter	Unit	Value
Maximum. Inf. Bit Rate	kbps	4050.0
TTI	ms	2
Number of HARQ Processes	Processes	8
Information Bit Payload (N_{INF})	Bits	8100
Binary Channel Bits per TTI (N_{BIN}) ($3840 / SF \times TTI$ sum for all channels)	Bits	11520
Coding Rate (N_{INF} / N_{BIN})		0.703
Physical Channel Codes	SF for each physical channel	{2,2,4,4}
E-DPDCH testing: E-DPDCH/DPCCH power ratio E-DPCCH/DPCCH power ratio	dB dB dB dB	Diversity: 6.02 Non-diversity: 8.94 Diversity: 0.0 Non-diversity: 2.05 E-DPDCH/DPCCH power ratio is calculated for a single E-DPDCH with SF 4. The power of an E-DPDCH with SF2 is twice that of an E-DPDCH with SF4.

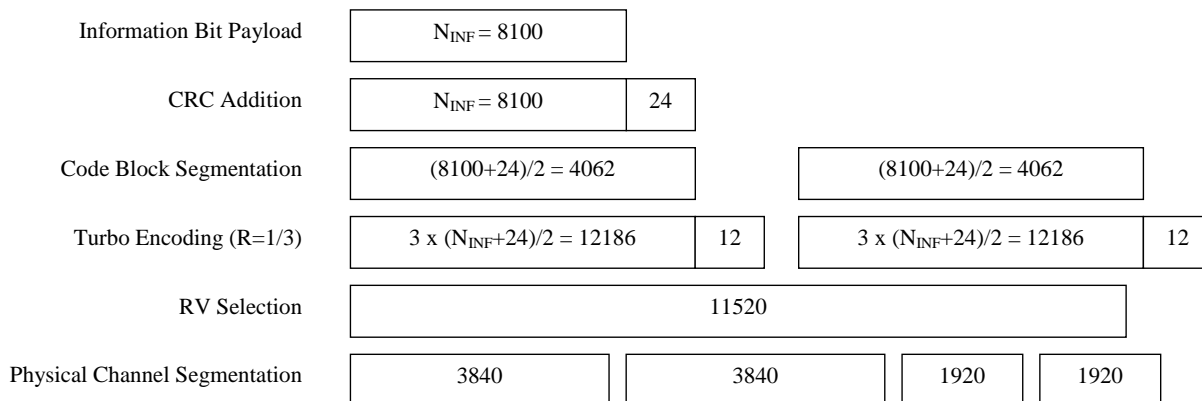

Figure A.12

A.13 E-DPDCH Fixed reference channel 4 (FRC4)

Table A.13

Parameter	Unit	Value
Maximum. Inf. Bit Rate	kbps	507.6
TTI	ms	10
Number of HARQ Processes	Processes	4
Information Bit Payload (N_{INF})	Bits	5076
Binary Channel Bits per TTI (N_{BIN}) ($3840 / SF \times TTI$ sum for all channels)	Bits	9600
Coding Rate (N_{INF} / N_{BIN})		0.529
Physical Channel Codes	SF for each physical channel	{4}
E-DPDCH testing: E-DPDCH/DPCCH power ratio	dB	Diversity: 8.94 Non-diversity: 12.04
E-DPCCH/DPCCH power ratio	dB	Diversity: -1.94 Non-diversity: 0.0
E-DPCCH missed detection testing: E-DPDCH/DPCCH power ratio	dB	Diversity: 8.94 Non-diversity: 12.04
E-DPCCH/DPCCH power ratio	dB	Diversity: -7.96 Non-diversity: -5.46

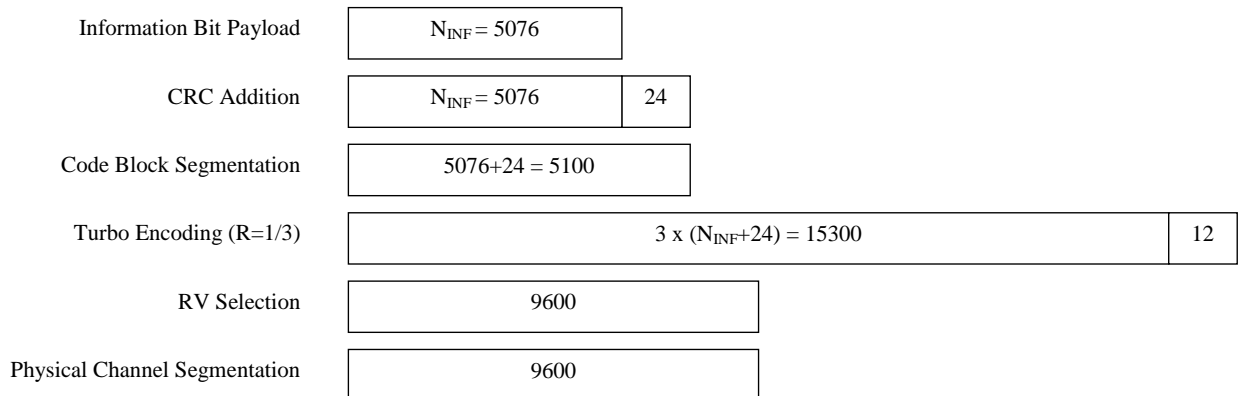

Figure A.13

A.14 E-DPDCH Fixed reference channel 5 (FRC5)

Table A.14

Parameter	Unit	Value
Maximum. Inf. Bit Rate	kbps	978.0
TTI	ms	10
Number of HARQ Processes	Processes	4
Information Bit Payload (N_{INF})	Bits	9780
Binary Channel Bits per TTI (N_{BIN}) (3840 / SF x TTI sum for all channels)	Bits	19200
Coding Rate (N_{INF}/ N_{BIN})		0.509
Physical Channel Codes	SF for each physical channel	{4,4}
E-DPDCH testing: E-DPDCH/DPCCH power ratio E-DPCCH/DPCCH power ratio	dB dB dB dB	Diversity: 8.94 Non-diversity: 12.04 Diversity: -1.94 Non-diversity: 0.0 E-DPDCH /DPCCH power ratio is calculated for a single E-DPDCH.

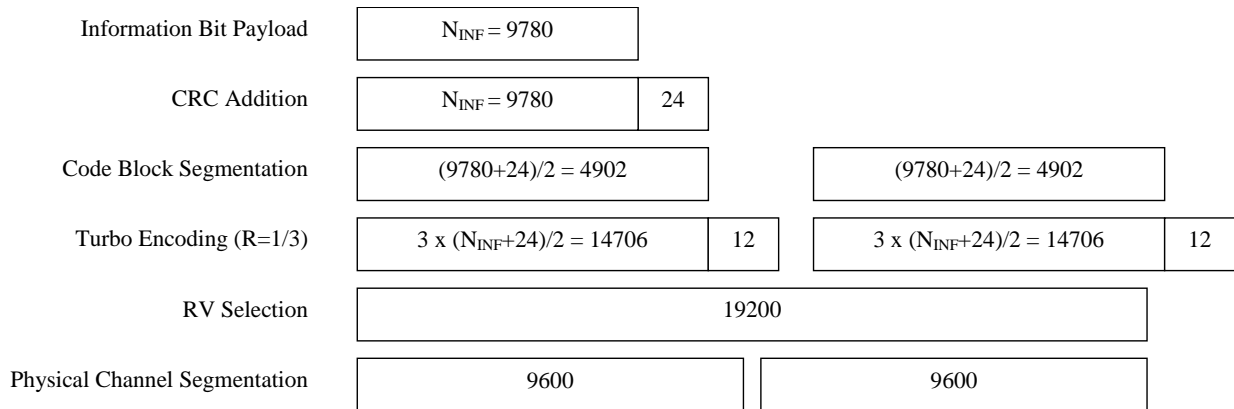

Figure A.14

A.15 E-DPDCH Fixed reference channel 6 (FRC6)

Table A.15

Parameter	Unit	Value
Maximum. Inf. Bit Rate	kbps	1927.8
TTI	ms	10
Number of HARQ Processes	Processes	4
Information Bit Payload (N_{INF})	Bits	19278
Binary Channel Bits per TTI (N_{BIN}) (3840 / SF x TTI sum for all channels)	Bits	38400
Coding Rate (N_{INF} / N_{BIN})		0.502
Physical Channel Codes	SF for each physical channel	{2,2}
E-DPDCH testing: E-DPDCH/DPCCH power ratio E-DPCCH/DPCCH power ratio	dB dB dB dB	Diversity: 9.92 Non-diversity: 13.00 Diversity: -5.46 Non-diversity: -1.94 E-DPDCH /DPCCH power ratio is calculated for a single E-DPDCH.

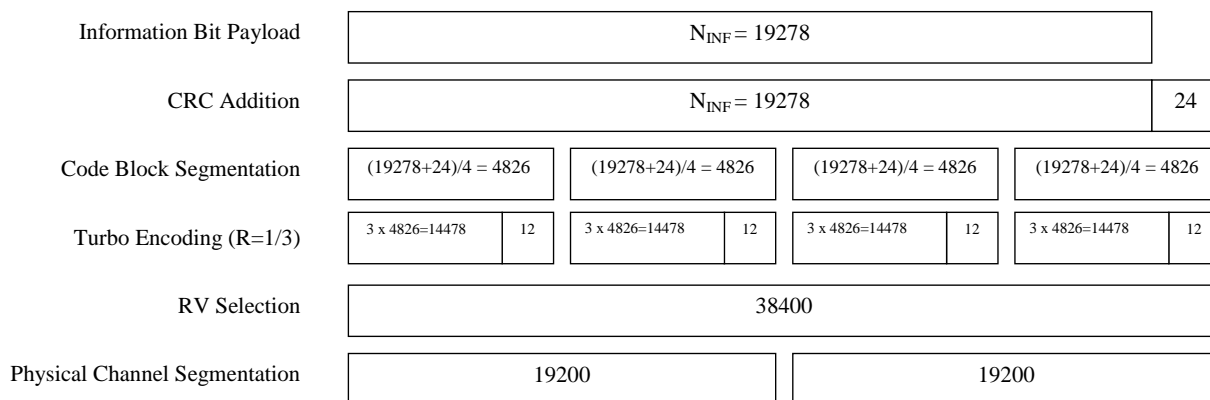

Figure A.15

A.16 E-DPDCH Fixed reference channel 7 (FRC7)

Table A.16

Parameter	Unit	Value
Maximum. Inf. Bit Rate	kbps	69.0
TTI	ms	10
Number of HARQ Processes	Processes	4
Information Bit Payload (N_{INF})	Bits	690
Binary Channel Bits per TTI (N_{BIN}) (3840 / SF x TTI sum for all channels)	Bits	2400
Coding Rate (N_{INF} / N_{BIN})		0.288
Physical Channel Codes	SF for each physical channel	{16}
E-DPDCH testing: E-DPDCH/DPCCH power ratio E-DPCCH/DPCCH power ratio	dB dB dB dB	Diversity: 6.02 Non-diversity: 8.94 Diversity: 0.0 Non-diversity: 4.08

Information Bit Payload	N _{INF} = 690	
CRC Addition	N _{INF} = 690	24
Code Block Segmentation	690+24 = 714	
Turbo Encoding (R=1/3)	3 x (N _{INF} +24) = 2142	
RV Selection	2400	
Physical Channel Segmentation	2400	

Figure A.16

A.17 E-DPDCH Fixed reference channel 8 (FRC8)

Table A.17

Parameter	Unit	Value
Modulation		16QAM
Maximum. Inf. Bit Rate	kbps	8109.0
TTI	ms	2
Number of HARQ Processes	Processes	8
Information Bit Payload (N _{INF})	Bits	16218
Binary Channel Bits per TTI (N _{BIN}) (3840 / SF x TTI sum for all channels)	Bits	23040
Coding Rate (N _{INF} / N _{BIN})		0.704
Physical Channel Codes	SF for each physical channel	{2,2,4,4}
E-DPDCH testing:		Non E-DPCCH boosting
E-DPDCH/DPCCH power ratio	dB	Diversity: 4.09
E-DPCCH/DPCCH power ratio	dB	Non-diversity: 6.98
	dB	Diversity: -9.54
	dB	Non-diversity: -5.46
Δ T2TP	dB	E-DPCCH Boosting
E-DPDCH/DPCCH power ratio	dB	Diversity: 12
	dB	Non-diversity: 15
E-DPCCH/DPCCH power ratio	dB	Diversity: 19.99
	dB	Non-diversity: 22.00
	dB	Diversity: 16.03
	dB	Non-diversity: 14.09
		E-DPDCH/DPCCH power ratio is calculated for a single E-DPDCH with SF 4. The power of an E-DPDCH with SF2 is twice that of an E-DPDCH with SF4.

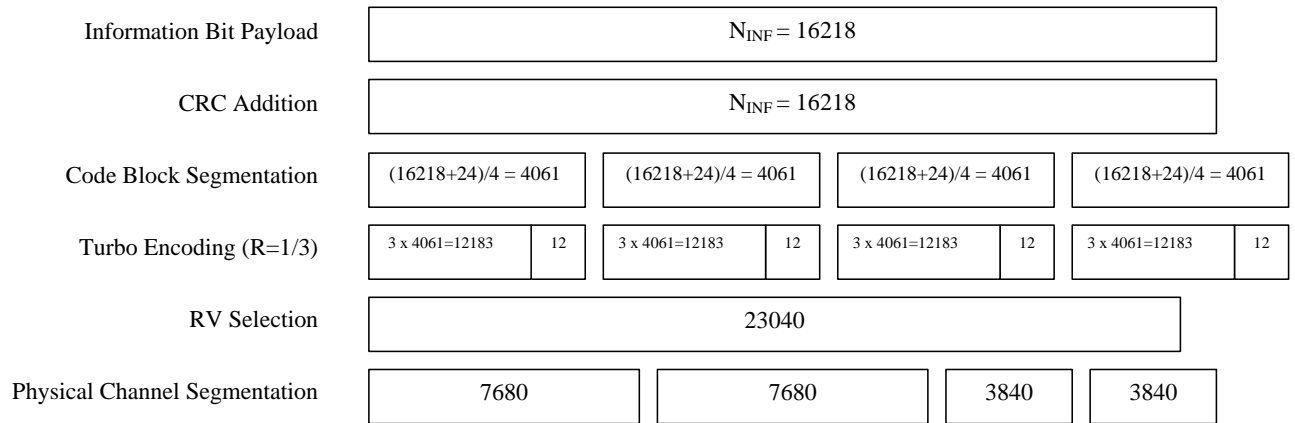

Figure A.17

Annex B (normative): Propagation conditions

B.1 Static propagation condition

The propagation for the static performance measurement is an Additive White Gaussian Noise (AWGN) environment. No fading or multi-paths exist for this propagation model.

B.2 Multi-path fading propagation conditions

Table B.1 shows propagation conditions that are used for the performance measurements in multi-path fading environment. All taps have classical Doppler spectrum, defined as:

$$(CLASS) \quad S(f) \propto 1/(1 - (f/f_D)^2)^{0.5} \quad \text{for } f \in [-f_D, f_D]$$

Table B.1: Propagation Conditions for Multi-path Fading Environments

Case 1		Case 2		Case 3		Case 4	
Speed for Band I, II, III, IV, IX, X 3 km/h		Speed for Band I, II, III, IV, IX, X 3 km/h		Speed for Band I, II, III, IV, IX, X 120 km/h		Speed for Band I, II, III, IV, IX, X 250 km/h	
Speed for Band V, VI, VIII, XIX 7 km/h		Speed for Band V, VI, VIII, XIX 7 km/h		Speed for Band V, VI, VIII, XIX 280 km/h		Speed for Band V, VI, VIII, XIX 583 km/h (Note 1)	
Speed for Band VII 2.3 km/h		Speed for Band VII 2.3 km/h		Speed for Band VII 92 km/h		Speed for Band VII 192 km/h	
Speed for Band XI, XXI 4.1 km/h		Speed for Band XI, XXI 4.1 km/h		Speed for Band XI, XXI 166 km/h		Speed for Band XI, XXI 345 km/h (Note 1)	
Speed for Band XII, XIII, XIV 8 km/h		Speed for Band XII, XIII, XIV 8 km/h		Speed for Band XII, XIII, XIV 320 km/h		Speed for Band XII, XIII, XIV 668 km/h	
Relative Delay [ns]	Average Power [dB]	Relative Delay [ns]	Average Power [dB]	Relative Delay [ns]	Average Power [dB]	Relative Delay [ns]	Average Power [dB]
0	0	0	0	0	0	0	0
976	-10	976	0	260	-3	260	-3
		20000	0	521	-6	521	-6
				781	-9	781	-9

NOTE 1: Speed above 250km/h is applicable to demodulation performance requirements only.

B.3 Moving propagation conditions

The dynamic propagation conditions for the test of the base band performance are non-fading channel models with two taps. The moving propagation condition has two tap, one static, Path0, and one moving, Path1. The time difference between the two paths is according Equation (B.1). The parameters for the equation are shown in Table B.2. The taps have equal strengths and equal phases.

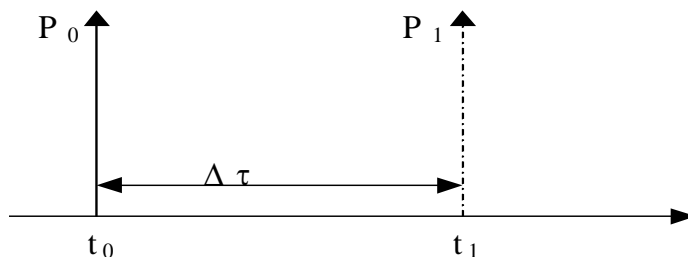

Figure B.1: The moving propagation conditions

$$\Delta\tau = B + \frac{A}{2}(1 + \sin(\Delta\omega \cdot t)) \tag{B.1}$$

Table B.2: Parameters for moving propagation

Parameter	Value
A	5 μs
B	1 μs
Δω	40·10 ⁻³ s ⁻¹

B.4 Birth-Death propagation conditions

The dynamic propagation conditions for the test of the baseband performance is a non-fading propagation channel with two taps. The birth-death propagation conditions has two taps, Path1 and Path2 which alternate between 'birth' and 'death'. The positions the paths appear are randomly selected with an equal probability rate and are shown in Figure B.2. For BS with receiver diversity, the same path positions shall be applied to both receiver antenna connectors, and the path switching times shall be synchronized on the two receiver antenna connectors, but the AWGN signals applied to the two receiver antenna connectors shall be uncorrelated.

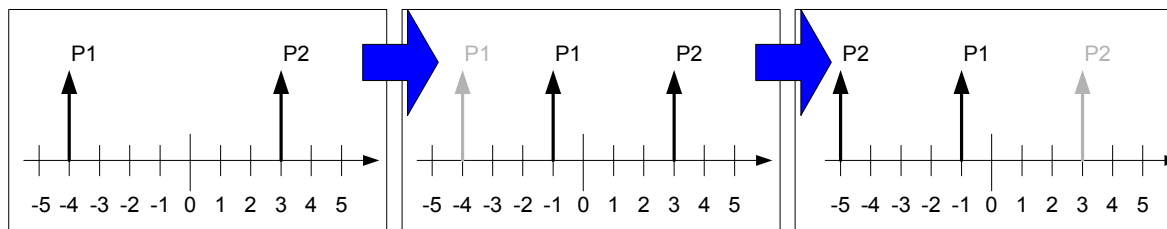

Figure B.2: Birth death propagation sequence

1. Two paths, Path1 and Path2 are randomly selected from the group [-5, -4, -3, -2, -1, 0, 1, 2, 3, 4, 5] μs. The paths have equal magnitudes and equal phases.
2. After 191 ms, Path1 vanishes and reappears immediately at a new location randomly selected from the group [-5, -4, -3, -2, -1, 0, 1, 2, 3, 4, 5] μs but excludes the point Path2. The magnitudes and the phases of the tap coefficients of Path 1 and Path 2 shall remain unaltered.
3. After an additional 191 ms, Path2 vanishes and reappears immediately at a new location randomly selected from the group [-5, -4, -3, -2, -1, 0, 1, 2, 3, 4, 5] μs but excludes the point Path1. The magnitudes and the phases of the tap coefficients of Path 1 and Path 2 shall remain unaltered.
4. The sequence in 2) and 3) is repeated.

B.4A High speed train conditions

High speed train conditions are as follows:

Scenario 1: Open space

Scenario 2: Tunnel with leaky cable

Scenario 3: Tunnel for multi-antennas

The high speed train conditions for the test of the baseband performance are 2 non fading propagation channels (scenario 1 and 3) and 1 fading propagation channel (scenario 2) with one tap. For BS with Rx diversity defined in scenario 1, the Doppler shift variation is the same between antennas.

For scenario 1 and 3, Doppler shift is given by:

$$f_s(t) = f_d \cos \theta(t) \quad (\text{B.2})$$

where $f_s(t)$ is the Doppler shift and f_d is the maximum Doppler frequency. The cosine of angle $\theta(t)$ is given by

$$\cos \theta(t) = \frac{D_s/2 - vt}{\sqrt{D_{\min}^2 + (D_s/2 - vt)^2}}, \quad 0 \leq t \leq D_s/v \quad (\text{B.3})$$

$$\cos \theta(t) = \frac{-1.5D_s + vt}{\sqrt{D_{\min}^2 + (-1.5D_s + vt)^2}}, \quad D_s/v < t \leq 2D_s/v$$

$$\cos \theta(t) = \cos \theta(t \bmod (2D_s/v)), \quad t > 2D_s/v$$

where $D_s/2$ is the initial distance of the train from BS, and D_{\min} is BS-Railway track distance, both in meters; v is the velocity of the train in m/s, t is time in seconds.

For scenario 2, Rician fading is considered where Rician factor, K is defined as the ratio between the dominant signal power and the variant of the other weaker signals.

Doppler shift and cosine angle is given by equation B.2 and B.3-B.5 respectively, where the required input parameters listed in table B.2A and the resulting Doppler shift shown in Figure B.3 and B.4 are applied for all frequency bands.

Table B.2A: Parameters for high speed train conditions

Parameter	Value		
	Scenario 1	Scenario 2	Scenario 3
D_s	1000 m	Infinity	300 m
D_{min}	50 m	-	2 m
K	-	10 dB	-
v	350 km/h	300 km/h	300 km/h
f_d	1340 Hz	1150 Hz	1150 Hz

NOTE1: Parameters for HST conditions in table B.2A including f_d and Doppler shift trajectories presented on figures B.3 and B.4 were derived for Band1.

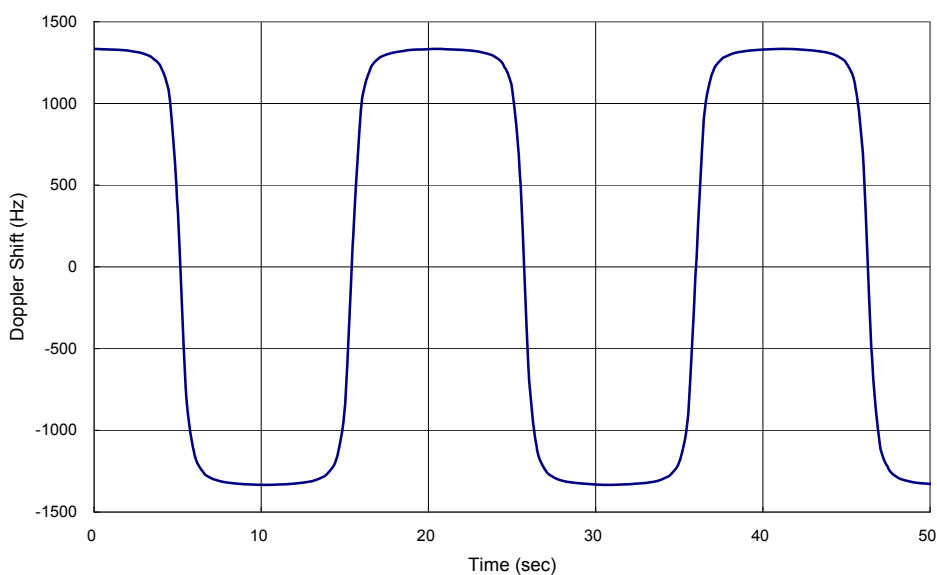

Figure B.3: Doppler shift trajectory for scenario 1

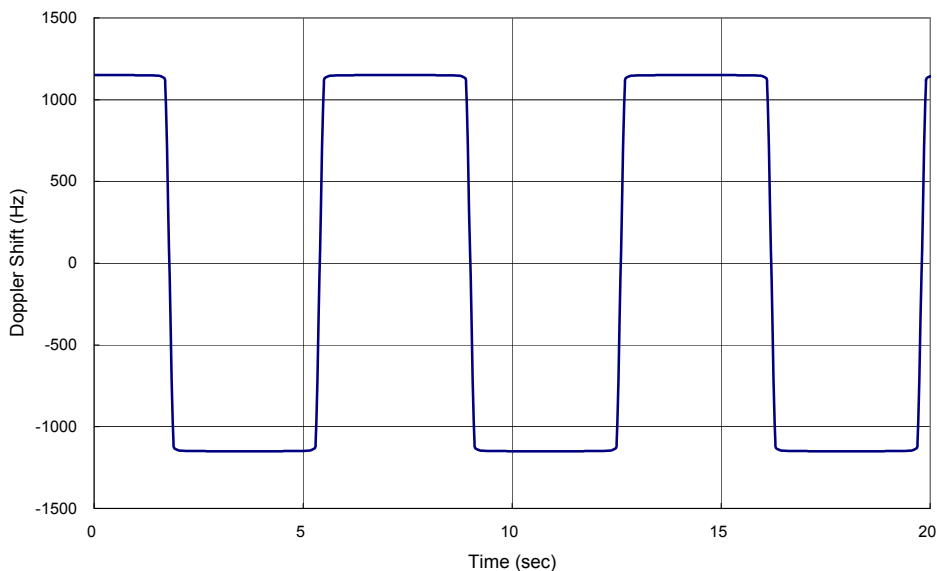

Figure B.4: Doppler shift trajectory for scenario 3

B.5 Multipath fading propagation conditions for E-DPDCH and E-DPCCH

Table B.3 shows propagation conditions that are used for E-DPDCH and E-DPCCH performance measurements in multipath fading environment. For DC-HSUPA requirements, the fading of the signals for each cell shall be independent.

Table B.3: Propagation Conditions for Multipath Fading Environments for E-DPDCH and E-DPCCH Performance Requirements

ITU Pedestrian A Speed 3km/h (PA3)		ITU Pedestrian B Speed 3km/h (PB3)		ITU vehicular A Speed 30km/h (VA30)		ITU vehicular A Speed 120km/h (VA120)	
Speed for Band I, II, III, IV, IX, X 3 km/h		Speed for Band I, II, III, IV, IX, X 3 km/h		Speed for Band I, II, III, IV, IX, X 30 km/h		Speed for Band I, II, III, IV, IX, X 120 km/h	
Speed for Band V, VI, VIII, XIX 7 km/h		Speed for Band V, VI, VIII, XIX 7 km/h		Speed for Band V, VI, VIII, XIX 71 km/h		Speed for Band V, VI, VIII, XIX 282 km/h (Note 1)	
Speed for Band VII 2.3 km/h		Speed for Band VII 2.3 km/h		Speed for Band VII 23 km/h		Speed for Band VII 92 km/h	
Speed for Band XI, XXI 4.1 km/h		Speed for Band XI, XXI 4.1 km/h		Speed for Band XI, XXI 41 km/h		Speed for Band XI, XXI 166 km/h (Note 1)	
Speed for Band XII, XIII, XIV 8 km/h		Speed for Band XII, XIII, XIV 8 km/h		Speed for Band XII, XIII, XIV 80 km/h		Speed for Band XII, XIII, XIV 320 km/h	
Relative Delay [ns]	Relative Mean Power [dB]	Relative Delay [ns]	Relative Mean Power [dB]	Relative Delay [ns]	Relative Mean Power [dB]	Relative Delay [ns]	Relative Mean Power [dB]
0	0	0	0	0	0	0	0
110	-9.7	200	-0.9	310	-1.0	310	-1.0
190	-19.2	800	-4.9	710	-9.0	710	-9.0
410	-22.8	1200	-8.0	1090	-10.0	1090	-10.0
		2300	-7.8	1730	-15.0	1730	-15.0
		3700	-23.9	2510	-20.0	2510	-20.0

NOTE 1: Speed above 120km/h is applicable to demodulation performance requirements only.

Annex C (normative): Characteristics of the W-CDMA interference signal

The W-CDMA interference signal shall be a DPCH containing the DPCCH and one DPDCH. The data content for each channelization code shall be uncorrelated with each other and to the wanted signal and spread and modulated according to clause 4 of TS25.213 [6]. Further characteristics of DPDCH and DPCCH are specified in table C.1.

Table C.1.: Characteristics of the W-CDMA interference signal

Channel	Bit Rate	Spreading Factor	Channelization Code	Relative Power
DPDCH	240 kbps	16	4	0 dB
DPCCH	15 kbps	256	0	-5.46 dB
NOTE: The DPDCH and DPCCH settings are chosen to simulate a signal with realistic Peak to Average Ratio.				

Annex D (informative): Change History

TSG	Doc	CR	R	Title	Cat	Curr	New	Work Item
37				Rel-8 version created based on v7.8.0			8.0.0	
37	RP-070658	0296		Introduction of UMTS1500 requirements (Rel-8)	B	7.8.0	8.0.0	RInImp8-UMTS1500
38	RP-070936	0299	1	Base station MIMO correction	A	8.0.0	8.1.0	MIMO-RF
38	RP-070937	0301		Spurious emission limits for coexistence with CDMA850	A	8.0.0	8.1.0	TEI7
39	RP-080120	0307		Correction to RX spurious emissions	A	8.1.0	8.2.0	TEI6
39	RP-080124	0302	1	Introduction of UMTS700 requirements (Band XII, XIII and XIV) in TS 25.104	B	8.1.0	8.2.0	RInImp8-UMTS700
40	RP-080326	0309	2	Correction on emission requirements for protection of public safety operations	F	8.2.0	8.3.0	RInImp8-UMTS700
40	RP-080326	0308		Correction to SEM references	F	8.2.0	8.3.0	TEI8
41	RP-080633	312	1	Transmitter characteristics of 3G Home NodeB	F	8.3.0	8.4.0	HNB-RF
41	RP-080633	312	1	Receiver characteristics of 3G Home NodeB	F	8.3.0	8.4.0	HNB-RF
				Editorial correction to Change History Table (previous two entries) [2008-10]		8.4.0	8.4.1	HNB-RF
42	RP-080927	315	1	Clarification of eNB HST propagation conditions (25.104, rel-8)	A	8.4.1	8.5.0	TEI7
42	RP-080945	318	1	HNB adjacent channel protection requirements	B	8.4.1	8.5.0	HNB-RF
42	RP-080945	321	1	Regional requirement on Home Node B applicability	F	8.4.1	8.5.0	HNB-RF
42	RP-080948	316		25.104 Modification due to DC-HSDPA	B	8.4.1	8.5.0	RANimp-DCHSDPA
43	RP-080192	322		Change bandwidth reference for ACLR limit for Home BS	F	8.5.1	8.6.0	HNB-RF
43	RP-080192	323		Clarification on 3G Home NodeB Transmit Power Conformance Testing for Adjacent Channel Protection	F	8.5.1	8.6.0	HNB-RF
43	RP-080195	324		25.104 CR Tx-Rx frequency separation for DC-HSDPA	F	8.5.1	8.6.0	RANimp-DCHSDPA
43	RP-080197	325		Co-existence requirement for the band 1880MHz	F	8.5.1	8.6.0	RInImp9-UMTS1880 TDD
44	RP-090553	328		Correction of local area base station coexistence spurious emission requirements	F	8.6.0	8.7.0	RInImp9-UMTS1880 TDD
44	RP-090605	326		Correction on Home BS Output Power Requirements for Adjacent Channel Protection	F	8.6.0	8.7.0	HNB-RF
44	RP-090559	327		Introduction of Extended UMTS800 requirements	B	8.7.0	9.0.0	RInImp9-UMTSLTE 800
45	RP-090827	338	1	Correction of DPCCH slot format for FRC8	A	9.0.0	9.1.0	TEI7
RP-46	RP-091286	339		Introduction of Extended UMTS1500 requirements for TS25.104 (Technically endorsed at RAN 4 52bis in R4-093625)	B	9.1.0	9.2.0	UMTSLTE1500
RP-46	RP-091276	341		Testing in case of Rx diversity, Tx diversity and MIMO (Technically endorsed at RAN 4 52bis in R4-093982)	A	9.1.0	9.2.0	TEI8

RP-46	RP-091289	342		Introduction of BS requirements for DB-DC-HSDPA (Technically Endorsed in R4-52, R4-092697)	B	9.1.0	9.2.0	RANimp-MultiBand_D C_HSDPA
RP-46	RP-091288	343		Introduction of the BS requirements for DC-HSUPA (Technically Endorsed in R4-52, R4-093332)	B	9.1.0	9.2.0	RANimp-DC_HSUPA
RP-46	RP-091277	345		Corrections on blocking performance requirement for Medium range BS for Band XII to Band XIV	A	9.1.0	9.2.0	TEI8
RP-46	RP-091277	347		Corrections on additional spectrum emission limits for Bands XII, XIII, XIV	A	9.1.0	9.2.0	TEI8
RP-46	RP-091296	348	1	Correction to the transmitter intermodulation	F	9.1.0	9.2.0	TEI9
RP-46	RP-091268	350	1	Protection of E-UTRA for UTRA BS	A	9.1.0	9.2.0	LTE-RF
RP-46	RP-091290	351	1	Definition and minimum requirement for time alignment error for DC-HSDPA-MIMO	B	9.1.0	9.2.0	RANimp-DC_MIMO
RP-46	RP-091296	356		Time alignment error definition correction for DC-HSDPA	A	9.1.0	9.2.0	TEI9